

TM 11-5820-498-12

DEPARTMENT OF THE ARMY TECHNICAL MANUAL

Operator's and Organizational Maintenance Manual

**RADIO SETS AN/VRC-53 (NSN 5820-00-223-7467),
AN/VRC-64 (NSN 5820-00-223-7475), AN/GRC-125
(NSN 5820-00-223-7411), AND AN/GRC-160
(NSN 5820-00-223-7473), AND AMPLIFIER-POWER
SUPPLY GROUPS OA-3633/GRC AND OA-3633A/GRC
(NSN 5820-00-973-3383)**

This copy is a reprint which includes current
pages from Changes 1 through 10.

**HEADQUARTERS, DEPARTMENT OF THE ARMY
MAY 1967**



5

SAFETY STEPS TO FOLLOW IF SOMEONE IS THE VICTIM OF ELECTRICAL SHOCK

1

DO NOT TRY TO PULL OR GRAB THE INDIVIDUAL

2

IF POSSIBLE , TURN OFF THE ELECTRICAL POWER

3

IF YOU CANNOT TURN OFF THE ELECTRICAL POWER, PULL, PUSH, OR LIFT THE PERSON TO SAFETY USING A WOODEN POLE OR A ROPE OR SOME OTHER INSULATING MATERIAL

4

SEND FOR HELP AS SOON AS POSSIBLE

5

AFTER THE INJURED PERSON IS FREE OF CONTACT WITH THE SOURCE OF ELECTRICAL SHOCK, MOVE THE PERSON A SHORT DISTANCE AWAY AND IMMEDIATELY START ARTIFICIAL RESUSCITATION

WARNING

SERIOUS INJURY OR EVEN DEATH CAN HAPPEN IF THE FOLLOWING ARE NOT CAREFULLY OBSERVED WHEN INSTALLING AND USING THE ANTENNAS USED WITH YOUR RADIO SETS.

**BEFORE ANY
MISSION FIND
OUT**

1. ARE THERE ANY POWERLINES IN YOUR AREA OF OPERATION ?
2. HOW HIGH ARE THESE POWERLINES ?
3. HOW TALL ARE THE POLES OR TOWERS CARRYING POWERLINES ?

MOBILE OPERATION WITH WHIP ANTENNAS

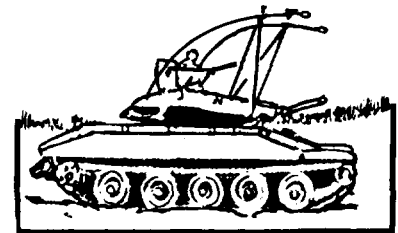
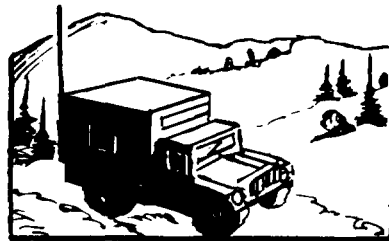
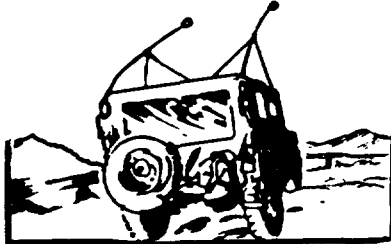

DO NOT STOP YOUR VEHICLE UNDER POWERLINES.

- IF POSSIBLE, TRY TO MAINTAIN MOBILE COMMUNICATIONS WITH YOUR ANTENNA(S) TIED DOWN.
- MAKE SURE AN ANTENNA TIP CAP IS SECURELY TAPED ON THE END OF EACH WHIP ANTENNA.
- DO NOT LEAN AGAINST OR TOUCH A WHIP ANTENNA WHILE THE TRANSMITTER IS ON.
- DURING CROSS-COUNTRY OPERATION, DO NOT ALLOW ANYONE TO STICK AN ARM, LEG OR WEAPON OVER THE SIDES OF THE VEHICLE. IF YOUR ANTENNA ACCIDENTALLY TOUCHES A POWERLINE AND A LEG, ARM OR WEAPON CONTACTS A DAMP BUSH OR THE GROUND, A SERIOUS OR FATAL ACCIDENT CAN HAPPEN.
- IF YOU ARE NOT SURE THAT AN ANTENNA ON YOUR VEHICLE WILL CLEAR A POWERLINE, STOP BEFORE YOU GET CLOSE TO THE POWERLINE AND EITHER CAREFULLY TIE DOWN THE ANTENNA OR REMOVE ANTENNA SECTIONS TO MAKE SURE THAT YOU CAN SAFELY DRIVE UNDER THE POWERLINE.

CHANGE }
No. 10 }

HEADQUARTERS
DEPARTMENT OF THE ARMY
Washington, DC, 15 June 1990

**Operator's and Organizational Maintenance Manual
RADIO SETS AN/VRC-53 (NSN 5820-00-223-7467),
AN/VRC-64 (NSN 5820-00-223-7475), AN/GRC-125
(NSN 5820-00-223-7411), AND AN/GRC-160
(NSN 5820-00-223-7473), AND AMPLIFIER-POWER
SUPPLY GROUPS OA-3633/GRC AND OA-3633A/GRC
(NSN 5820-00-973-3383)**

TM 11-5820-498-12, 31 May 1967, is changed as follows:

1. Remove old pages and insert new pages as indicated below. New or changed material is indicated by a vertical bar in the margin of the page. Added or revised illustrations are indicated by a vertical bar adjacent to the identification number or by a pointing hand on the illustration page.

<u>Remove pages</u>	<u>Insert pages</u>
1-1 and 1-2	1-1 and 1-2
1-6.1.	1-6.1/(1-6.2 blank)
1-19 through 1-22.	1-19 through 1-22
2-1 and 2-2.	2-1 and 2-2
2-5 through 2-10.	2-5 through 2-10
3-1 and 3-2.	3-1 and 3-2
3-11 and 3-12.	3-11 and 3-12
4-1 through 4-11	4-1 through 4-11/(4-12 blank)
5-1 through 5-2.2	5-1 through 5-2.2
5-5 through 5-9.	5-5 through 5-9/(5-10 blank)
6-4.1 through 6-6.	6-4.1 through 6-6
A-1 through A-3	A-1 through A-4
B-5 and B-6.	B-5 and B-6
C-3 through C-8.	C-3 through C-8
D-3 and D-4.	D-3 and D-4
E-3/ (E-4 blank)	E-3/(E-4 blank)

2. File this change sheet in front of the publication for reference purposes.

Distribution authorized to the Department of Defense and DOD contractors only for official use or for administration or operational purposes. This determination was made on 5 July 1988. Other requests for this document will be referred to Commander, US Army Communications-Electronics Command and Fort Monmouth, ATTN: AMSEL-LC-ME-P, Fort Monmouth, NJ 07703-5000.

DESTRUCTION NOTICE-Destroy by any method that will prevent disclosure of contents or reconstruction of the document.

By Order of the Secretary of the Army:

CARL E. VUONO
General, United States Army
Chief of Staff

Official:

WILLIAM J. MEEHAN II
Brigadier General, United States Army
The Adjutant General

DISTRIBUTION:

To be distributed in accordance with DA Form 12-51 DS/GS requirements for AN/VRC-53, -64, AN/GRC-125, -160.

CHANGE }
No.9 }

HEADQUARTERS
DEPARTMENT OF THE ARMY
WASHINGTON, DC, 27 October 1981

**Operator's and Organizational Maintenance Manual
RADIO SETS AN/VRC-53 (NSN 5820-00-223-7467),
AN/VRC-64 (NSN 5820-00-223-7475), AN/GRC-125
(NSN 5820-00-223-7411), AND AN/GRC-160
(NSN 5820-00-223-7473), AND AMPLIFIER-POWER
SUPPLY GROUPS OA-3633/GRC AND OA-3633A/GRC
(NSN 5820-00-973-3383)**

TM 11-5820-49812, 31 May 1967, is changed as follows:

- 1. New or changed material is indicated by a bar in the margin.
- 2. Remove and insert pages as indicated below:

<i>Remove</i>	<i>Insert</i>
None	A and B
1-1 and 1-2	1-1 and 1-2
1-6.1	1-6.1
1-21 and 1-22	1-21 and 1-22
2-1 and 2-2	2-1 and 2-2
2-5 and 2-6	2-5 and 2-6.1
4-1 through 4-6	4-1 through 4-6.1
5-1 through 5-2.2	5-1 through 5-2.2
6-4.1 through 6-6	6-4.1 through 6-6
A-1 through A-3	A-1 through A-3
E-3	E-3
I-3	I-3

- 3. File this change sheet on the front of the manual for reference purposes.

By Order of the Secretary of the Army:

Official

ROBERT M. JOYCE
Brigadier General, United States Army
The Adjutant General

E.C.MEYER
General, United States Army
Chief of Staff

Distribution:

To be distributed in accordance with DA Form 12-51, Operator Maintenance requirements for AN/VRC-53, AN/VRC-64, AN/GRC-125, and AN/GRO-160.

WARNINGS

Prevent personal injury when applying or removing steel strapping by wearing heavy gloves and a protective face shield. Do not handle packing cartons by the steel strapping.

Extreme caution must be taken when making connections for the purpose of testing, charging, or repairing batteries that are charging or have been recently removed from charging. Such batteries probably will be gassing and the slightest spark can cause the battery to explode. Personnel working with these batteries are urged to wear a pair of tight fitting goggles, or better still, the newest types of plastic mask which covers the entire face.

Open flames, cigarettes, radio transmitters, generating sets open-cage electric motors, or any other type of equipment that may cause sparks must be kept clear of the charging line.

WARNINGS

A minimum of two persons will be utilized in handling or lifting any item in excess of 40 pounds. Extreme care will be used in handling to prevent injury to individuals or damage to equipment.

Adequate ventilation should be provided while using TRICHLOROTRIFLUOROETHANE. Prolonged breathing of vapor should be avoided. The solvent should not be used near heat or open flame; the products of decomposition are toxic and irritating. Since TRICHLOROTRIFLUOROETHANE dissolves natural oils, prolonged contact with skin should be avoided. When necessary, use gloves which the solvent cannot penetrate. If the solvent is taken internally, consult a physician immediately.

WARNINGS

A lithium battery is used in this equipment, and is potentially hazardous if misused or tampered with before, during, and after discharge. The following precautions must be strictly observed to prevent possible injury to personnel or damage to equipment.

DO NOT heat, incinerate, crush, puncture, disassemble, or otherwise mutilate the batteries.

DO NOT short circuit.

DO NOT recharge.

DO NOT bypass internal fuse or replace with a fuse of a different rating. Replacement fuses are packed two per every ten batteries.

DO NOT store in equipment during long periods of unuse in excess of 30 days.

TURN OFF the equipment immediately if you detect the battery compartment becoming unduly hot or rapidly increasing in temperature, hear battery venting (hissing sound), or smell irritating sulfur dioxide gas. Remove and dispose of the battery only after it is cool (30-60 minutes).

DO NOT use carbon dioxide extinguishers on exposed lithium metal fires. Flood the burning material with water or use graphite type compounds or extinguishers to extinguish burning lithium.

CHANGE }
No. 8 }

HEADQUARTERS
DEPARTMENT OF THE ARMY
WASHINGTON, DC, 25 January 1979

**Operator's and Organizational Maintenance Manual
RADIO SETS AN/VRC-53 (NSN 5820-00-223-7467),
AN/VRC-64 (NSN 5820-00-223-7475), AN/GRC-125
(NSN 5820-00-223-7411), AND AN/GRC-160
(NSN 5820-00-223-7473), AND AMPLIFIER-POWER
SUPPLY GROUPS OA-3633/GRC AND OA-3633A/GRC
(NSN 5820-00-973-3383)**

TM 11-5820-498-12, 31 May 1967, is changed as follows:

- 1. New or changed material is indicated by a bar in the margin.
- 2. Remove and insert pages as indicated below:

<i>Remove</i>	<i>Insert</i>
None	0-1 and 0-2 (after front cover)
1-1 and 1-2	1-1 and 1-2
1-9 and 1-10	1-9 and 1-10
4-3 through 4-6	4-3 through 4-6
5-1 through 5-2.3	5-1 through 5-2.2
6-3 and 6-4	6-3 through 6-4.2
6-11 and 6-12	6-11 through 6-12.1
E-3	E-3

- 3. File this change sheet in the front of the manual for reference purposes.

By Order of the Secretary of the Army:

BERNARD W. ROGERS
General, United States Army
Chief of Staff

Official:

J.C. PENNINGTON
Brigadier General, United States Army
The Adjutant General

Distribution:

To be distributed in accordance with DA Form 12-51, Operator maintenance requirements for AN/VRC-53, AN/VRC-64, AN/GRC-125 and AN/GRC-160.

WARNING

SERIOUS INJURY OR EVEN DEATH CAN HAPPEN IF THE FOLLOWING ARE NOT CAREFULLY OBSERVED WHEN INSTALLING AND USING THE ANTENNAS USED WITH YOUR RADIO SETS.

**BEFORE ANY
MISSION FIND
OUT**

1. ARE THERE ANY POWERLINES IN YOUR AREA OF OPERATION ?
2. HOW HIGH ARE THESE POWERLINES ?
3. HOW TALL ARE THE POLES OR TOWERS CARRYING POWERLINES ?

MOBILE OPERATION WITH WHIP ANTENNAS

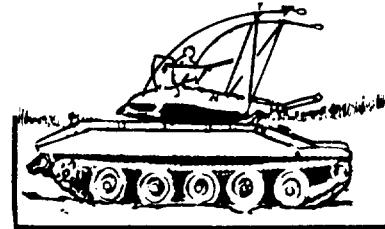
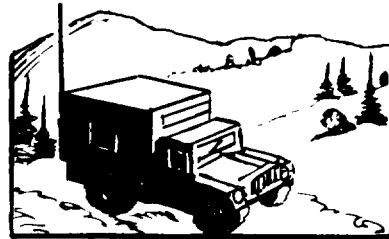
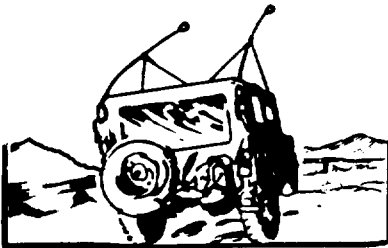

DO NOT STOP YOUR VEHICLE UNDER POWERLINES.

- IF POSSIBLE, TRY TO MAINTAIN MOBILE COMMUNICATIONS WITH YOUR ANTENNA(S) TIED DOWN.
- MAKE SURE AN ANTENNA TIP CAP IS SECURELY TAPED ON THE END OF EACH WHIP ANTENNA.
- DO NOT LEAN AGAINST OR TOUCH A WHIP ANTENNA WHILE THE TRANSMITTER IS ON.
- DURING CROSS-COUNTRY OPERATION, DO NOT ALLOW ANYONE TO STICK AN ARM, LEG OR WEAPON OVER THE SIDES OF THE VEHICLE. IF YOUR ANTENNA ACCIDENTALLY TOUCHES A POWERLINE AND A LEG, ARM OR WEAPON CONTACTS A DAMP BUSH OR THE GROUND, A SERIOUS FATAL ACCIDENT CAN HAPPEN.
- IF YOU ARE NOT SURE THAT AN ANTENNA ON YOUR VEHICLE WILL CLEAR A POWERLINE, STOP BEFORE YOU GET CLOSE TO THE POWERLINE AND EITHER CAREFULLY TIE DOWN THE ANTENNA OR REMOVE ANTENNA SECTIONS TO MAKE SURE THAT YOU CAN SAFELY DRIVE UNDER THE POWERLINE.

CHANGE }
No.7 }

HEADQUARTERS
DEPARTMENT OF THE ARMY
Washington, DC, 16 December 1977

Operator's and Organizational Maintenance Manual
RADIO SETS AN/VRC-53 (NSN 5820-00-223-7467),
AN/VRC-64 (NSN 5820-00-223-7475), AN/GRC-125
(NSN 5820-00-223-7411), AND AN/GRC-160
(NSN 5820-00-223-7473), AND AMPLIFIER-POWER
SUPPLY GROUPS OA-3633/GRC AND OA-3633A/GRC
(NSN 5820-00-973-3383)

TM 11-5820-498-12, 31 May 1967, is changed as follows:

1. New or changed material is indicated by a bar in the margin.
2. Remove and insert pages as indicated below:

<i>Remove pages</i>	<i>Insert pages</i>
WARNING instructions	WARNING instructions
i and 1-0	i and 1-0
1-3 through 1-6	1-3 through 1-6
1-7 and 1-8	None
1-9 and 1-10	1-9 and 1-10
2-7 through 2-12	2-7 through
4-1 through 4-6.	4-1 through
4-11 through 4-12	4-11
5-1 through 5-4.	5-1 through 5-4.
None	B-1 through
None	D-1 through
None.	E-1 and E-2

3. File this change sheet in the front of the manual for reference purposes.

By Order of the Secretary of the Army:

Official:

J.C. PENNINGTON
Brigadier General, United States Army
The Adjutant General

BERNARD W. ROGERS
General, United States Army
Chief of Staff

Distribution:

To be distributed in accordance with DA Form 12-51, operator maintenance requirements for AN/VRC-53, AN/VRC-64, AN/GRC-125 and AN/GRC-160.

CHANGE }
No. 6 }

HEADQUARTERS
DEPARTMENT OF THE ARMY
WASHINGTON, DC, 15 September 1977

**Operator's and Organizational Maintenance Manual
Radio Sets AN/VRC-53 (NSN 5820-00-223-7467)
AN/VRC-64 (NSN 5820-00-223-7475),
AN/GRC-125 (NSN 5820-00-223-7411),
AND AN/GRC-160 (NSN 5820-00-223-7473),
AND
AMPLIFIER-POWER SUPPLY GROUPS OA-3633/GRC
AND OA-3633A/GRC (NSN 5820-00-973-3383)**

TM 11-5820-498-12, 31 May 1967, is changed as follows:

1. The title of the manual is changed as shown above.
2. New or changed material is indicated by a bar in the margin.
3. Remove and insert pages as indicated in the page list below.

<i>Remove</i>	<i>Insert</i>
i and 1-0 -----	i and 1-0
1-1 and 1-2 -----	1-1 and 1-2
1-17 and 1-18 -----	1-17 and 1-18
2-5 and 2-6 -----	2-5 and 2-6
2-11 -----	2-11 and 2-12
4-5 and 4-6 -----	4-5 and 4-6
4-11 and 4-12 -----	4-11 and 4-12
5-7 through 5-9 -----	5-7 through 5-9
6-9 and 6-10 -----	6-9 and 6-10
A-1 and A-2 -----	A-1 and A-2
B-1 through B-8 -----	B-1 through B-8
C-1 through C-10 -----	C-1 through C-8

4. File this change in the front of the manual for future reference.

By Order of the Secretary of the Army:

Official:

J. C. PENNINGTON
Brigadier General, United States Army
The Adjutant General

BERNARD W. ROGERS
General, United States Army
Chief of Staff

Distribution:

To be distributed in accordance with DA Form 12-51, Operator maintenance requirements for AN/VRG-53, AN/VRC-64, AN/GRC-125 and AN/GRC-160.

CHANGE }
No. 5 }

HEADQUARTERS
DEPARTMENT OF THE ARMY
WASHINGTON, D. C., 9 August 1973

**Operator's and Organizational Maintenance Manual Including Repair Parts
and Special Tools Lists**

**RADIO SETS AN/VRC-53, AN/VRC-64, AN/GRC-125,
AND AN/GRC-160; AND AMPLIFIER-POWER SUPPLY GROUPS OA-3633/GRC
AND OA-3633A/GRC**

TM 11-5820-498-12, 31 May 1967, is changed as follows:

1. Remove and insert pages as indicated below.
2. New or changed material is indicated by a vertical bar in the margin of the page. Added or revised illustrations are indicated by the change number appearing in the identification number.

Remove pages

WARNING page (Change 3)
1-1 and 1-2
1-5 through 1-14
1-17 and 1-18
1-23
2-1 through 2-26
2-11
3-3 and 3-4
3-7 and 3-8
3-13 through 3-15
4-1 and 4-2
4-5 and 4-6
4-11 and 4-12
5-1 and 5-2
5-7 through 5-9
6-3 and 6-4
7-1, 7-2, and 7-3
A-1 and A-2
C-3 through C-10

Insert pages

WARNING page
i and 1-0
1-1 and 1-2
1-5 through 1-14
1-17 and 1-18
None
2-1 through 2-6
2-11
3-3 and 3-4
3-7 and 3-8
3-13 through 3-15
4-1 and 4-2
4-5 and 4-6
4-11 and 4-12
5-1 and 5-2
5-7 through 5-9
6-3 and 6-4
None
A-1 and A-2
C-3 through C-9

3. File this change sheet in the front of the manual.

By Order of the Secretary of the Army:

Official:

VERNE L. BOWERS
Major General, United States Army
The Adjutant General

CREIGHTON W. ABRAMS
General, United States Army
Chief of Staff

Distribution:

To be distributed in accordance with DA Form 12-51 (qty rqr lock No. 693) Operator Maintenance Requirements for AN/VRC-53.

CHANGE }
 No. 4 }

HEADQUARTERS
 DEPARTMENT OF THE ARMY
 WASHINGTON, D.C., 23 February 1972

**Operator's and Organizational Maintenance Manual
 Including Repair Parts and Special Tools Lists**

**RADIO SETS AN/VRC-53, AN/VRC-64, AN/GRC-125 AND
 AN/GRC-160 AND AMPLIFIER POWER-SUPPLY GROUPS
 OA-3633/GRC AND OA-3633A/GRC**

TM 11-5820-498-12, 31 May 1967, is changed as follows:

1. Title is changed as shown above.
2. Remove and insert pages as indicated in the page list below.

<i>Remove pages—</i>	<i>Insert pages—</i>
i, 1-0 - - - - -	-i, 1-0
1-1 through 1-18- - - - -	-1-1 through 1-23
2-3, 2-4 - - - - -	-2-3, 2-4
3-11, 3-12 - - - - -	-3-11, 3-12
6-1, 6-2 - - - - -	-6-1 through 6-2.1
A-1, A-2 - - - - -	-A-1, A-2
B-1 through B-8 - - - - -	-B-1 through B-8
3. File this change sheet in the front of the manual for reference purposes.

By Order of the Secretary of the Army:

Official:

VERNE L. BOWERS,
*Major General, United States Army,
 The Adjutant General.*

W. C. WESTMORELAND,
*General, United States Army,
 Chief of Staff.*

Distribution:

To be distributed in accordance with DA Form 12-51, Operator maintenance requirements for AN/GRC-125, AN/VRC-53 and OA-3633/GRC radio equipments.

*This change supersedes that portion of TM 11-5820-498-25P, 25 April 1966, as pertains to organizational maintenance repair parts and special tools list.

CHANGE }
 No. 3 }

HEADQUARTERS
 DEPARTMENT OF THE ARMY
 WASHINGTON, D.C., 19 January 1971

Operator's and Organizational Maintenance Manual
RADIO SETS AN/VRC-53, AN/VRC-64, AN/GRC-125, AND
AN/GRC-160 AND AMPLIFIER-POWER SUPPLY GROUPS
OA-3633/GRC AND OA-3633A/GRC

TM 11-5820-498-12, 31 May 1967, is changed as follows:

1. New or changed material is indicated by a vertical bar.
2. Remove old pages and insert new pages as indicated in the page list below.

<i>Remove pages</i>	<i>Insert Pages</i>
A	New "Warning" Page
1-1 and 1-2	1-1 and 1-2
2-3 through 2-6	2-3 through 2-6
3-5 and 3-6	3-5 and 3-6
4-5 and 4-6	4-5 and 4-6
4-11 and 4-12	4-11 and 4-12
5-1 through 5-6	5-1 through 5-6
6-5 and 6-6	6-5 and 6-6
6-22.1	6-22.1
C-1 through C-14	C-1 through C-10

3. File this change sheet in front of the publication for reference purposes.

By Order of the Secretary of the Army:

Official:

KENNETH G. WICKHAM,
Major General, United States Army,
The Adjutant General.

W. C. WESTMORELAND,
General, United States Army,
Chief of Staff.

Distribution:

To be distributed in accordance with DA Form 12-51, operator maintenance requirements for the AN/GRC-125, AN/VRC-53, and OA-3633/GRC radio sets.

CHANGE }
 No. 2 }

HEADQUARTERS
 DEPARTMENT OF THE ARMY
 WASHINGTON, D. C., 3 October 1969

**Operator's and Organizational Maintenance Manual
 RADIO SETS AN/VRC-53, AN/VRC-64, AN/GRC-125,
 AND AN/GRC-160 AND AMPLIFIER-POWER SUPPLY
 GROUPS OA-3633/GRC AND OA-3633A/GRC**

TM 11-5820-498-12, 31 May 1967, is changed as follows:

1. This change provides the following changes:
 - a. Additional caution notices.
 - b. Information on use of Cap, Electrical CW-922/GRC.
 - c. Identification of connections at switchboard for RWI operation.
 - d. Information on OA-3633A/GRC.
 - e. New basic issue items list (BIIL's) for radio sets.
 - f. New maintenance allocation chart for OA-3633/GRC and OA-3633A/GRC.
2. The title of the manual is changed as indicated above.
3. Remove and insert pages as indicated below:

<i>Remove—</i>	<i>Insert—</i>
Delete "Warning" from page 2 of cover - - - - -	New "Warning" Page A
1-1, 1-2 - - - - -	1-1—1-2.1
1-8.1 and 1-8.2- - - - -	1-8.1—1-8.4
1-9, 1-10 - - - - -	1-9
1-13—1-17 - - - - -	1-13—1-18
2-3—2-8 - - - - -	2-3—2-11
3-7—3-10 - - - - -	3-7—3-10
5-7 - - - - -	5-7
5-8, 5-9 - - - - -	5-8, 5-9
6-17, 6-18 - - - - -	6-17, 6-18
Figure 6-13 - - - - -	6-22.1
A-1, A-2 - - - - -	A-1, A-2
B-3, B-4 - - - - -	B-3, B-4
B-7, B-8 - - - - -	B-7, B-8
C-13, C-14 - - - - -	C-13, C-14

4. File this change sheet in the front of the manual.

By Order of the Secretary of the Army:

W. C. WESTMORELAND,
General, United States Army,
Chief of Staff.

Official:

KENNETH G. WICKHAM,
Major General, United States Army,
The Adjutant General.

Distribution: To be distributed in accordance with DA Form 12-51, Operator maintenance requirements for AN/GRC-125, AN/VRC-53 and OA-3633/GRC radio sets.

CHANGE }
No. 1 }

HEADQUARTERS
DEPARTMENT OF THE ARMY
WASHINGTON, D. C., 26 September 1968

Operator and Organizational Maintenance Manual
RADIO SETS AN/VRC-53, AN/VRC-64, AN/GRC-125,
AND AN/GRC-160 AND AMPLIFIER-POWER SUPPLY
GROUP OA-3633/GRC

TM 11-5820-498-12, 31 May 1967, is changed as follows:

The title is changed as shown above.

Remove and insert pages as indicated below.

<i>Remove—</i>	<i>Insert—</i>
.....	Page 2 of cover
1-1 through 1-8	1-1 through 1-8.2
3-1 and 3-2	3-1 and 3-2
6-3 through 6-8.	6-3 through 6-24
A-1 and A-2	A-1 and A-2
B-1 through B-5.	B-1 through B-6
C-1 through C-7.	C-1 through C-14

File this transmittal sheet in the front of the manual.

By Order of the Secretary of the Army:

W. C. WESTMORELAND,
*General, United States Army,
Chief of Staff.*

Official:

KENNETH G. WICKHAM,
*Major General, United States Army,
The Adjutant General*

Distribution:

To be distributed in accordance with DA Form 12-51, operator maintenance requirements for AN/VRC-53, AN/GRC-125, and OA-3633/GRC Radio Sets.

* U.S. GOVERNMENT PRINTING OFFICE: 1968—344440/78

WARNING

Do not permit man-pack or vehicular whip antennas to touch high powerlines or other sources of electricity; injury or death could result. Observe the requirements of TB SIG 291 which illustrates the dangers of permitting an antenna to contact other sources of power.

CAUTIONS

1. Remove battery from Batter Box CY-2562/PRC-25 when the receiver-transmitter is vehicular installed.
2. When the cover of receiver module 1st RF amplifier A3 in the RT-505/PRC-25 (part of AN/VRC-53, AN/GRC-125, and AN/PRC-25) is not inscribed with the words "CR1 MOD ADDED", do not approach closer than approximately 25 feet to high power radio sets, such as Radio Sets AN/VRC-12, AN/VRC-46, AN/VRC-47, and AN/VRC-49, and similar high power radio sets. Damage to this module can occur when these radios are transmitting on high power, even when the TT-505/PRC-25 is turned off. The distance need not be maintained when module A3 has the words "CR1 MOD ADDED" on its cover, or when the module is identified with the reference designation A33 (which is the version of the module in the RT-841/PRC-77).
3. Do not operate the radio within 3 megacycles of the operating frequency of another radio that is less than approximately 25 feet away. Mutual interference can occur.
4. DO NOT REVERSE the connections of the radio power cable leads at the vehicular battery. The proper colored cable leads for each battery terminal is shown in figure 2-3. Damage to resistors and diodes in the Amplifier-Power Supply (AM-2060/GRC and AM-2060A/GRC) may result if the leads are reversed at the battery terminals.
5. DO NOT KEY the receiver-transmitter (by operating the handset push-to-talk switch or holding the audio accessory switch at RADIO position) while changing channels or the BAND switch. Module damage may occur or the frequency of the new channel may be incorrect.
6. DO NOT START THE VEHICLE ENGINE, restart it, slave-start, or stop it with the amplifier power supply or the AM-1780/VRC turned on. The amplifier power supply PWR switch must be set to OFF and, if used, the AM-1780/VRC MAIN PWR switch must also be set to OFF. Install WARNING decals as instructed in SB 11-624.

TECHNICAL MANUAL }
 No. 11-5820-498-12 }

HEADQUARTERS
 DEPARTMENT OF THE ARMY
 WASHINGTON, DC, 31 May 1967

**OPERATOR'S AND ORGANIZATIONAL MAINTENANCE MANUAL
 RADIO SETS AN/VRC-53
 (NSN 5820-00-223-7467), AN/VRC-64
 (NSN 5820-00-223-7475), AN/GRC-125
 (NSN 5820-00-223-7411), AND AN/GRC-160
 (NSN 5820-00-223-7473) AND AMPLIFIER-POWER
 SUPPLY GROUPS OA-3633/GRC AND
 OA-3633A/GRC (NSN 5820-00-973-3383)**

	Paragraph	Page
CHAPTER	1. INTRODUCTION	
Section	I. General	1-1
	II. Description and data	1-2
CHAPTER	2. INSTALLATION	
Section	I. Service upon receipt of equipment	2-1
	II. Installation	2-3
CHAPTER	3. OPERATING INSTRUCTIONS	
Section	I. Operator's controls, indicators, end connectors	3-1
	II. Operation under usual conditions.	3-6
CHAPTER	4. OPERATOR'S MAINTENANCE INSTRUCTIONS	4-1
	5. ORGANIZATIONAL MAINTENANCE INSTRUCTIONS	
Section	I. General.	5-1
	II. Preventive maintenance	5-3
	III. Troubleshooting	5-12
CHAPTER	6. MATERIAL USED IN CONJUNCTION WITH RADIO SETS	
Section	I. Audio and intercommunication equipment	6-1
	II. Audio accessories and minor components	6-2
	III. Other equipment used with radio sets	6-4
	IV. Cables used with radio sets and intercom	6-22
APPENDIX	A. APPENDIX	A-1
	B. COMPONENTS OF END ITEM LIST	B-1
	C. MAINTENANCE ALLOCATION	C-1
	D. ADDITIONAL AUTHORIZATION LIST	D-1
	E. EXPENDABLE SUPPLIES AND MATERIALS LIST	E-1
INDEX.	I-1

* This manual supersedes TM 11-5820-498-10, 5 November 1962; C 1, 29 March 1963; and C 2, 3 July 1963; and TM 11-5820-4920, 5 November 1962; and C 1, 14 December 1964.



Figure 1-1. Radio Set AN/VRC-53 or AN/VRC-64 installed in vehicle.

1-0 Change 7

Section I. GENERAL

1-1. Scope

a. This manual describes Radio Sets AN/VRC-53, AN/VRC-64, AN/GRC-125, and AN/GRC-160, and Amplifier-Power Supply Groups OA-3633/GRC and OA-3633A/GRC and covers their operation and organizational maintenance.

b. Publications covering operation, maintenance, and repair parts listing for components of, and equipment used with above equipment are listed in appendix A, and paragraph 1-4b).

c. Unless otherwise indicated in this manual:

(1) Receiver-transmitter refers to Receiver-Transmitters, Radio RT-505/PRC-25 and RT-841/PRC-77.

(2) Amplifier power supply refers to Amplifier-Power Supply Groups OA-3633/GRC and OA-3633A/GRC, and Amplifier-Power Supplies AM-2060/GRC and AM-2060A/GRC. OA-3633(*)/GRC refers to OA-3633/GRC and OA-3633A/GRC; AM-2060(*)/GRC refers to AM-2060/GRC and AM-2060A/GRC.

(3) Handset refers to Handsets H-138(*)/U, H-189/GR, and H-250/U. (*) indicates H-138/U and H-138A/U.)

(4) Antenna refers to Antennas AT912/VRC and AS-1729/VRC.

(5) Vehicular radio sets refer to Radio Sets AN/VRC-53, AN/VRC-64, AN/GRC-125, and AN/GRC-160.

(6) Man-pack radio refers to the use of the receiver-transmitter of the AN/GRC-125 and AN/GRC-160 man-pack components (Handset, whip antenna, Harness, Electrical Equipment ST-138/PRC-25).

d. Refer to paragraph 1-9 a for differences between the OA-3633/GRC and OA-3633A/GRC and to paragraph 1-9c for differences between the AM-2060/GRC and AM-2060A/GRC.

1-2. Consolidated Index of Army Publications and Blank Forms

Refer to the latest issue of DA Pam 25-30 to determine whether there are new editions, changes or additional publications pertaining to the equipment.

1-3. Maintenance Forms, Records and Reports

a. *Reports of Maintenance and Unsatisfactory Equipment.* Department of the Army forms and procedures used for equipment maintenance will be those prescribed by DA Pam 738-750 as contained in Maintenance Management Update.

b. *Reporting of Item and Packaging Discrepancies.* Fill out and forward SF 364 (Report of Discrepancy (ROD)) as prescribed in AR 735-11-2/DLAR 4140.55/SECNAVINST 4355.18/AFR 400-54/MCO 4430.3J

c. *Transportation Discrepancy Report (TDR) (SF 361).* Fill out and forward Transportation Discrepancy Report (TDR) (SF 361) as prescribed in AR 55-38/NAVSUPINST 4610.33C/AFR 75-18/MCO P4610.19D/DLAR 4500.15.

1-3.1 Reporting Errors and Recommending Improvements

You can help improve this manual. If you find any mistakes or if you know of a way to improve the procedures, please let us know. Mail your letter or DA Form 2028 (Recommended Changes to Publications and Blank Forms) direct to: Commander, US Army Communications-Electronics Command and Fort Monmouth, ATTN: AMSEL-LC-ME-PS, Fort Monmouth, New Jersey 07703-5000.

1-3.2. Reporting Equipment Improvement Recommendations (EIR)

If your equipment needs improvement, let us know. Send us an EIR. You, the user, are the only one who can tell us what you don't like about your equipment. Let us know why you don't like the design or performance. Put it on an SF 368 (Product Quality Deficiency Report). Mail it to: Commander, US Army Communications-Electronics Command and Fort Monmouth, ATTN: AMSEL-PA-MA-D, Fort Monmouth, New Jersey 07703-5000. We'll send you a reply.

1-3.3. Administrative Storage

Administrative storage of the equipment will be handled as follows. The requirements apply whether the equipment is stored as part of the vehicle or stored without the vehicle.

a. Check and remove the battery from the receiver-transmitter (para 2-6a). Clean the battery box.

b. Before and after storage, perform the following:

(1) Inventory the equipment (app B).

(2) Clean the equipment.

(3) Perform operator's and organizational PMCS (table 4-1 and para 5-5). Correct all deficiencies. For uncorrected deficiencies, tag and date the deficiencies.

c. During storage, inventory the equipment.

d. Store the equipment in a dry and moisture-free area with safeguards against pilfering.

1-3.4. Destruction of Army Electronics Materiel

Destruction of Army electronics materiel to prevent enemy use shall be prescribed in TM 750-244-2.

1-3.5. Hand Receipt Technical Manual

A Hand Receipt Technical Manual, TM 11-5820-498-12-HR, is available. It contains preprinted DA Form 2062 (Hand Receipt/Annex No.) listing the components of each of the radio sets and also the components of the radio installation kits of wheeled vehicles and the components of the harnesses and accessory kits of tracked vehicles in which these radio sets are installed.

The Hand Receipt manual is published to aid property accountability and is available through: Commander, US Army Adjutant General Publications Center, ATTN: AGDL-OD, 1655 Woodson Road, St. Louis, Missouri 63114 or through The Adjutant General publications channels. The Hand Receipt publication is entitled: Hand Receipt Technical Manual Covering End Item/Components of End Item (COEI), Basic Issue Items (BII), and Additional Authorization List (AAL), Related to Radio Sets AN/VRC-53 (NSN 5820-00-223-7467), AN/VRC-64 (NSN 5820-00-223-7475), AN/GRC-125 (NSN 5820-00-223-7411), and AN/GRC-160 (NSN 5820-00-223-7473).

Section II. DESCRIPTION AND DATA

1-4. Purpose and Use

a. The radio sets provide short-range, two-way, frequency-modulated (fm) radiotelephone communication between vehicles and crew-served weapons (such as tanks, armored personnel carriers, etc.). The radio sets are compatible with other fm radio sets in 30.00- to 75.95 megacycle (mc) range (fig. 1-5).

b. Radio Sets AN/VRC-53 and AN/VRC-64 are vehicular radio sets (fig. 1-10). Radio Sets AN/GRC-125 and AN/GRC-160 have the components for vehicular (fig. 1-1) and man-pack operation (fig. 1-2). The following chart provides comments on the radio sets and some of their components:

Item	Receiver-transmitter used	Remarks
AN/VRC-53 AN/VRC-64 AN/GRC-125.....	RT-505/PRC-25 RT-841/PRC-77 RT-505/PRC-25	Vehicular radio configuration (fig. 1-1). Vehicular radio configuration. With one RT-505/PRC-25, provides vehicular AN/VRC-53 or man-pack AN/PRC-25 (TM 11-5820-398-12) (fig. 1-2).
AN/GRC-160.....	RT-841/PRC-77	With one RT-841/PRC-77, provides vehicular AN-VRC-64 or man-pack AN/PRC-77 (TM 11-5820-667-12).
RT-505/PRC-25 and RT-841/PRC-77.		Functionally, operationally, and in appearance identical to each other. RT-841/PRC-77 also has capability for handling X-mode operation; the RT-505/PRC-25 does not have this capability.
OA-3633(*)/GRC (fig. 1-3)	RT-505/PRC-25 or RT-841/PRC-77.	Provides conversion of vehicular battery to operating voltages for receiver-transmitter which is mounted on it. It also provides for antenna control connection and has a loudspeaker for radio reception.
AS-1729/VRC and AT-912/VRC Installation kit and audio accessories	Two-section vehicular whip antennas. See <i>c</i> below.

c. The radio sets (para 1-6a), as such are not operational; they require a power cable for connection to the vehicular electrical system, a radio mount (fig. 1-8), a radio frequency (RF) cable and a control cable between the receiver-transmitter and the whip antenna, audio accessories for talking and listening, and a 22-28-volt dc power source. Paragraph 1-6b contains particulars concerning the equipment required to make the radio sets operational.

d. The radio sets can be used alone or in conjunction with radio/intercom equipment (fig. 1-4), such as Intercommunication Set AN/VIC-1(V) (fig. 6-1). The radio/intercom equipment is provided in tracked vehicles, such as tanks, armored personnel carriers, armored command posts, etc.

(1) In tracked vehicles the AN/VIC-1(V) consists of Audio Frequency Amplifier AM-1780/VRC (para 6-1) and Controls, Intercommunication Set C-2298/VRC (para 6-4) for each crewmember.

(2) In such vehicles as tanks, the AN/VIC-1(V) also includes Control, Intercommunication Set (C-2297/VRC (para 6-3) for the driver and Control, Intercommunication Set C-2296/VRC (para 6-2) mounted on the outside of the tank.

(3) The controls provide facilities for the crewmembers, using helmets in which are installed audio accessories (para 6-10), to com-

municate on the radio set and to communicate on the intercom between crewmembers.

e. The radio sets can also be used in conjunction with other equipment as described in (1) through (8) below.

(1) Power Supply PP-2953/U can be used in fixed installations to provide operating dc power (para 6- 14).

(2) Antenna equipment RC-292 can be used in place of the vehicular whip antenna to extend the communication distance (para 6-15).

(3) Antenna AT-984A/G (para 6-16) which is a long wire-type of antenna can also be used in place of the vehicular whip antenna for extended communication range in one direction.

(4) Antenna, Loop AT-784/PRC can be used in the man-pack configuration of the AN/GRC-125 and AN/GRC-160 (fig. 1-2) for homing-in on radio stations and marker beacons (para 6- 17).

(5) The radio sets can be connected to each other or to radio sets in the AN/VRC-12 radio series for radio relay use by means of the cable in Retransmission Cable Kit MK-456/GRC (para 6-13).

(6) Remote control of the radio sets can be provided by Radio Set Control Group AN/GRA-39(*) (para 6-12a) and Radio Set Control AN/GRA-6 (para 6-20a).

(7) Radio/wire integration operation with the radio sets and remote telephone facilities can

be provided by Radio Set Control AN/GSA-7 and Oscillator O-574/GRC (para 6-19). The AN/GRA-39(*) (para 6-12b) and AN/GRA-6 (para 6-20b) can also be used for radio/wire integration operation.

(8) The RT-841/PRC-77 used in the

AN/VRC-64 and AN/GRC-160 has provision for passing wideband audio signals which are usually associated with secure-voice equipment (X-mode operation). The RT-505/PRC-25 used in the AN/VRC-53 and AN/GRC-125 has no provision for wideband operation.



TM5820-498-10-2

Figure 1-2. Man-pack use of Radio Set AN/GRC-125 or AN/GRC-160.

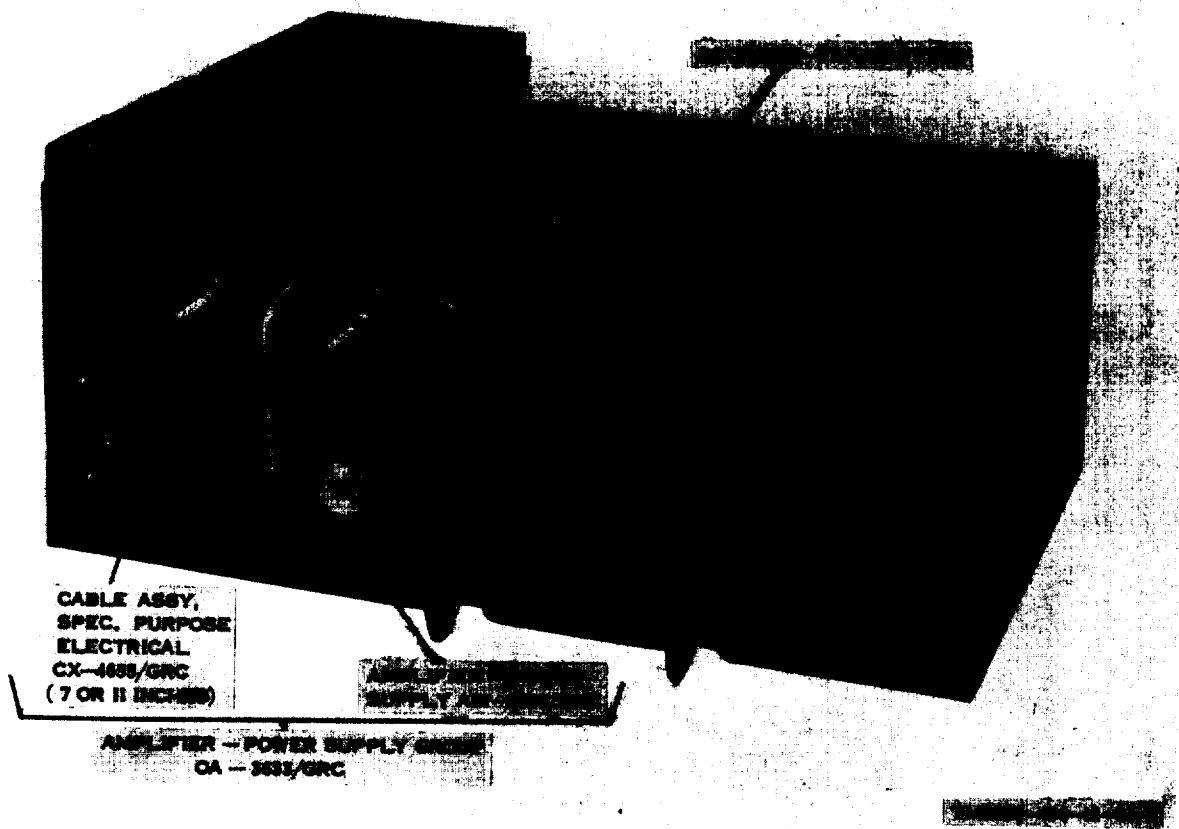

Figure 1-3. Amplifier-Power Supply Group OA-3633(*)/GRC with receiver-transmitter installed.

1-5. Technical Characteristics

a. Receiver-Transmitter.

Frequency range:

Low band	30.00 to 52.95 mc.
High band	53.00 to 75.95 mc.
Number of channels (preset frequencies)	920.
Channel (frequency separation)	50 kc (0.05 mc).
Type of modulation	FM.
Type of squelch	Tone operated by 150-cps tone.
Audio transmission and reception capability:	
Method	Push-to-talk and release-to-receive.
Transmission:	
Narrow band	Voice (300 to 3,000 cps) and 150-cps squelch tone.
Wideband (applies to RT-841/PRC-77 only)	15 to 20,000 cps and 150-cps squelch tone.
Reception:	
Narrow band	Voice and no squelch; or voice and 150-cps squelch tone.

Wideband (applies to RT-841/PRC-77 only).
 Transmitter power output
 Power requirements:
 Transmission:
 RT-505/PRC-25
 RT-841/PRC-25
 Reception:
 RT-505/PRC-25
 RT-841/PRC-77
 Antennas:
 AN/VRC-53 and AN/VRC-64
 AN/GRC-125 and AN/GRC-160:
 AN/VRC-53 and AN/VRC-64
 (vehicular configuration).....
 AN/PRC-25 and AN/PRC-77
 (man-pack configuration)
 Man-pack battery

b. Amplifier-Power Supply Group OA-3633()/GRC:*
 Input voltage
 Output voltage
 Frequency response of loudspeaker

15 to 20,000 cps and no squelch tone; or 15 to 20,000 cps and 150-cps squelch tone.
 1 to 3 watts (approx).
 2.5 to 3 volts dc (tube filament) (0.4 amp (approx)); 12.5 to 15 volts dc (B +) (1.4 amp (approx)).
 12.5 to 15 volts dc (B +) (0.78 amp (approx)).
 12.5 to 15 volts dc (0.6 amp (approx)).
 12.5 to 15 volts dc (0.06 amp (approx)).
 Antenna AS-1729/VRC (Antenna AT-912/VRC may be used in lieu of AS-1729/VRC).
 Antenna AS-1729/VRC (Antenna AT-912/VRC may be used in lieu of AS-1729/VRC).
 Antenna AT-271A/PRC (10 ft. multisecton whip); or Antenna AT-892/PRC-25 (3 ft. semirigid whip).
 Battery, Dry BA-4386/U (Magnesium) ■
 Battery, Dry BA-5598/U (Lithium) ■
 for arctic use: AN/PRC-77 only
 22 to 28 volts dc.
 13 volts dc (regulated); 3 volts dc, regulated; 2.6 volts dc (unregulated).
 300 to 3,000 cps.

1-6. Components of Radio Sets and Items Required to Make Radio Sets Operational

a. Components. Refer to appendix B for the listing of the components of the radio sets.

NOTE

Antenna AT-912/VRC (fig. 1-9) (NSN

5820-00-897-6357) may be issued in lieu of the AS-1729/VRC. The AT-912/VRC includes the following: Antenna Element AT-1095/VRC (NSN 5820-00-856-2728), Antenna Element AT-1096/VRC (NSN 5820-00-856-2730); Antenna Matching Unit MX-2799/VRC (NSN 5820-00-897-6356), Base, Antenna Support AB-719/VRC (NSN 5820-00-856-2729), and four mounting bolts, washers, and nuts

(Pages 1-7 and 1-8 removed.)

b. Items Required to Make Radio Sets Operational.

(1) *General.* Items required to make radio sets (a above) operational are supplied by various means. The means depend on the particular application of the radio set. Dc power (22–28 volts) is provided by vehicular battery system.

(a) SB 11-131 lists the parts and stock numbers of the installation kits, vehicle radio/intercom harnesses, and accessory kits authorized for installing radio sets in wheeled and tracked vehicles.

(b) Installation kits contain the appropriate audio accessories (microphones, headset-microphone sets, handsets, etc.) (fig. 6-2), Mounting MT-1029/VRC (fig. 1-8), interconnecting cables (fig. 1-12), power cables (fig. 1-11), and hardware necessary to mount the equipment in the vehicle. The installation kits also include installation and cabling instructions.

(c) The radio/intercom harnesses are part of tracked vehicles. They include crew-member control boxes and AM-1780/VRC (fig. 6-1; (f) below), Mounting MT-1029/VRC for the OA-3633(*)/GRC, interconnecting and power cables (figs. 1-11, 1-12, and 6-14), and the electrical transient suppressor (3) (d) or (e) below).

(d) Accessory kits complement the radio/intercom harnesses. They include audio accessories (fig. 6-2), some interconnecting cables, and instructions for installing radio/intercom harness and accessory kit.

(e) General purpose installation kits are provided for nonvehicular installation. They contain audio accessories, Mounting MT-1029/VRC, interconnecting cables, power cables, and general purpose mounting hardware.

(f) Intercommunication Set AN/VIC-1(V) (fig. 6-1) includes Amplifier, Audio Frequency AM-1780/VRC and two to four Controls, Intercommunication Set C-2298/VRC for the crewmembers of the vehicle. In most radio/intercom harnesses of tanks and similar vehicles the AN/VIC-1(V) also includes Control, Intercommunication Set C-2297/VRC for the driver and Control, Intercommunication Set C-2296/VRC mounted on the outside of the vehicle.

(2) *Wheeled vehicles.*

(a) Representative wheeled vehicle include: Truck, Cargo, ¼-Ton, 4 x 4, M151A-1; Truck, Cargo, 1¼-Ton, 4 x 4, M715; etc.

(b) The items requisitioned for installation and operation of the radio sets for each particular vehicle are provided in installation kits ((1) (b) above).

(3) *Tracked vehicles.*

(a) Representative tracked (combat) vehicles include: Tanks, Full-Tracked, M60A1, M60A2, M60A3; Carrier, Personnel, Armored, M113; Carrier Command Post M577; etc.

(b) The items required for installation and operation of the radio sets for each particular tracked vehicle are provided in the radio/intercom harness in the vehicle ((1) (c) above) and an accessory kit ((1) (d) above).

(c) The audio accessory for some tracked vehicles (M60A1, M551, etc) is contained in a combat vehicle crewman (CVC) helmet (type T56-6, fig. 6-3) and in automotive vehicle crewman (AVC) helmet (type DH-132, fig. 6-3.1). In CVC helmet, Headset-Microphone Kit MK-1039/G is installed; in AVC helmet, Headset-Microphone Kit MK-1697/G is installed. See paragraph 6-10 for further details.

(d) Electrical Transient Suppressor MX-7778/GRC (TM 11-5915-223-12) or MX-7778A/GRC (TM 11-5915-224-14) is provided in tracked vehicles to protect the radio equipment from electrical transient voltages that may be in the vehicular electrical system. Instructions for installing the installation kit for the MX-7778/GRC and MX-7778A/GRC are provided in TB 11-2300-457-30.

(e) In Tanks M60A1 (RISE version), M60A2, and M60A3 and Armored Assault Vehicles M551 and M551A1, a mini-suppressor is provided instead of the MX-7778/GRC and MX-7778A/GRC. The mini-suppressor is mounted on the back of the MT-1029/VRC and is connected to J23 of the mounting (fig. 2-8). Detailed instructions for mini-suppressor application, installation, and maintenance are provided in SB 11-638.

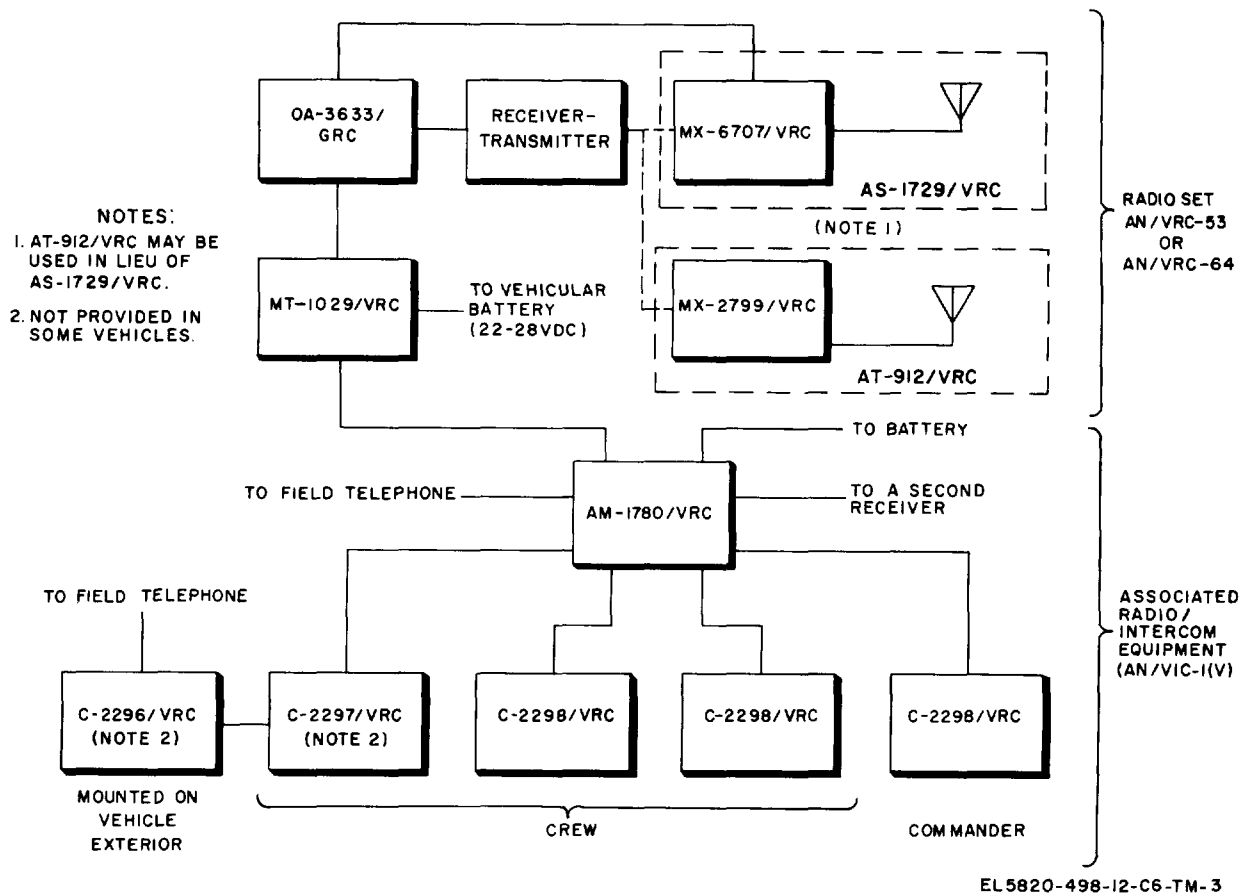

Figure 1-4. Radio Sets AN/VRC-53 and AN/VRC-64 typical configuration with radio/intercom equipment.

1-7. System Application

Figure 1-4 shows the typical configuration of the radio sets and also when the radio sets are operated in conjunction with the radio/intercom equipment. Figure 1-5 and the following chart show various frequency-modulated (FM) radios with which the receiver-transmitters in the AN/VRC-53, AN/VRC-64, AN/GRC-125, and AN/GRC-160 can communicate within 30- to

75.95-mc band. The chart below lists the frequency ranges and channel spacing of the radio sets and associated publications. All radios listed, except those in which preset crystals are required, can tune to any frequency within its operating range. Take note of the channel spacing in kilocycles (kc). For example, communication with the AN/PRC-6 can occur on 50.00, 50.20, and 50.40 MC, etc.

Radio set	Frequency range (mc)	Channel spacing: every	Publication	Remarks
AN/VRC-53, AN/VRC-64, AN/VRC-125, and AN/GRC-160 ^a .	30-75.95	50 kc	TM 11-5820-498-12	Channels provided by preset crystals.
AN/VRC-12, AN/VRC-43 through AN/VRC-49 ^a .	30-75.95	50 kc	TM 11-5820-401-12	
AN/VRC-54, AN/VRC-55 ^b	30-75.95	50 kc	TM 11-5820-401-12	
AN/PRC-25 ^c	30-75.95	50 kc	TM 11-5820-398-12	
AN/PRC-77 ^c	30-75.95	50 kc	TM 11-5820-667-12	
AN/PRC-6.....	47-55.4	200 kc	TM 11-296	

Radio set	Frequency range (mc)	Channel spacing: every	Publication	Remarks
AN/PRC-9	30-38.90	100 kc	TM 11-5820-292-10	When modified by reducing transmitter deviation.
AN/PRC-10	38-54.90	100 kc	TM 11-5820-292-10	
AN/PRC-28	30-42.00	100 kc	TM 11-5820-292-10	
AN/ARC-44	24-51.90	100 kc	TM 11-5821-204-12	
AN/ARC-54 ^a	30-69.95	50 kc	TM 11-5821-244-12	Used also for radio relay. Uses either AN/ARC-54 or AN/ARC-131.
AN/ARC-114 ^a	30-75.95	50 kc	TM 11-5821-259-20	
AN/ARC-131 ^a	30-75.95	50kc	TM 11-5820-670-12	
AN/ASC-10(V) ^a	30-69.95	50 kc	TM 11-5821-276-15	
	or 30-75.95		(Rescinded)	
AN/ASC-11 ^b -Deleted-				Includes AN/ARC-131.
AN/ASC-15 ^a	30-75.95	50kc	TM 11-5821-285-12	

Radio set	Frequency range (mc)	Channel spacing: every	Publication	Remarks
AN/GRC-163 ^a	30-75.95	50 kc	TM 11-5820-713-12	Includes AN/VRC-47.
AN/FSQ-75 ^b	30-75.95	50 kc	TM 11-5895-590-10	
AN/TSQ-70A ^b	30-75.95	50 kc	TM 11-5895-579-12	
AN/TSQ-71A ^b	30-75.95	50 kc	TM 11-5895-474-12	
AN/PRR-9 ^a	47-57	100 kc	TM 11-5820-549-12	
AN/PRT-4, AN/PRT-4A ^a	47-57	100 kc	TM 11-5820-549-12	Squad radio; can only receive.
RT-67/GRC in—	27-38.90	100 kc		Squad radio; can only transmit; AN/PRT-4 does not transmit 150-cps squelch tone.
AN/GRC-5, AN/GRC-6			TM 11-284	
AN/VRQ-2			TM 11-287	
AN/VRC-9			TM 11-286	
AN/VRC-14			TM 11-291	
AN/VRC-17			TM 11-611	
AN/VRC-21			TM 11-642	
RT-68/GRC in—	38-54.90	100 kc		
AN/GRC-7, AN/GRC-8			TM 11-284	
AN/VRQ-3			TM 11-287	
AN/VRC-10			TM 11-286	
AN/VRC-15			TM 11-291	
AN/VRC-18			TM 11-611	
AN/VRC-22			TM 11-642	
RT-70/GRC in—	47-58.40	100 kc	TM 11-290	
AN/GRC-5 through AN/GRC-8.			TM 11-284	
AN/VRC-7			TM 11-285	

^aThese radios have a squelch feature in their receiver-transmitters and receivers that make them compatible with the RT-505/PRC-25 and RT-841/PRC-77 for squelch operation. Refer to paragraph 3-12 for squelch operation conditions.

^bThese are radio configurations in which AN/VRC-46 or AN/VRC-49 is a component.

1-8. Description of Receiver-Transmitters
(fig. 1-6)

a. Each receiver-transmitter is a push-to-talk fm receiver-transmitter. It is mounted and connected to the amplifier-power supply and the vehicle whip antenna for vehicular radio operation. For man-pack operation, the receiver-transmitter is removed from the amplifier-power supply and carried by the user (fig. 2-5).

b. The RT-841/PRC-77 may be used with wideband (X-mode) equipment; the RT-505/PRC-25 has no provision for wideband operation.

c. On the outside, the RT-505/PRC-25 and RT-841/PRC-77 are identical. Inside many of the modules in both units are identical; the remaining modules are not interchangeable.

d. The receiver-transmitter is housed in a watertight case and secured with four captive screws. All controls are on the front panel. A battery plug projects from the rear of the unit and mates with the receptacle on the battery. Battery Box CY-2562/PRC-25 is part of the receiver-transmitter. It is a lightweight, metal case that protects and houses the battery. The battery sits on a foam-rubber pad which is fastened to the bottom of the case.

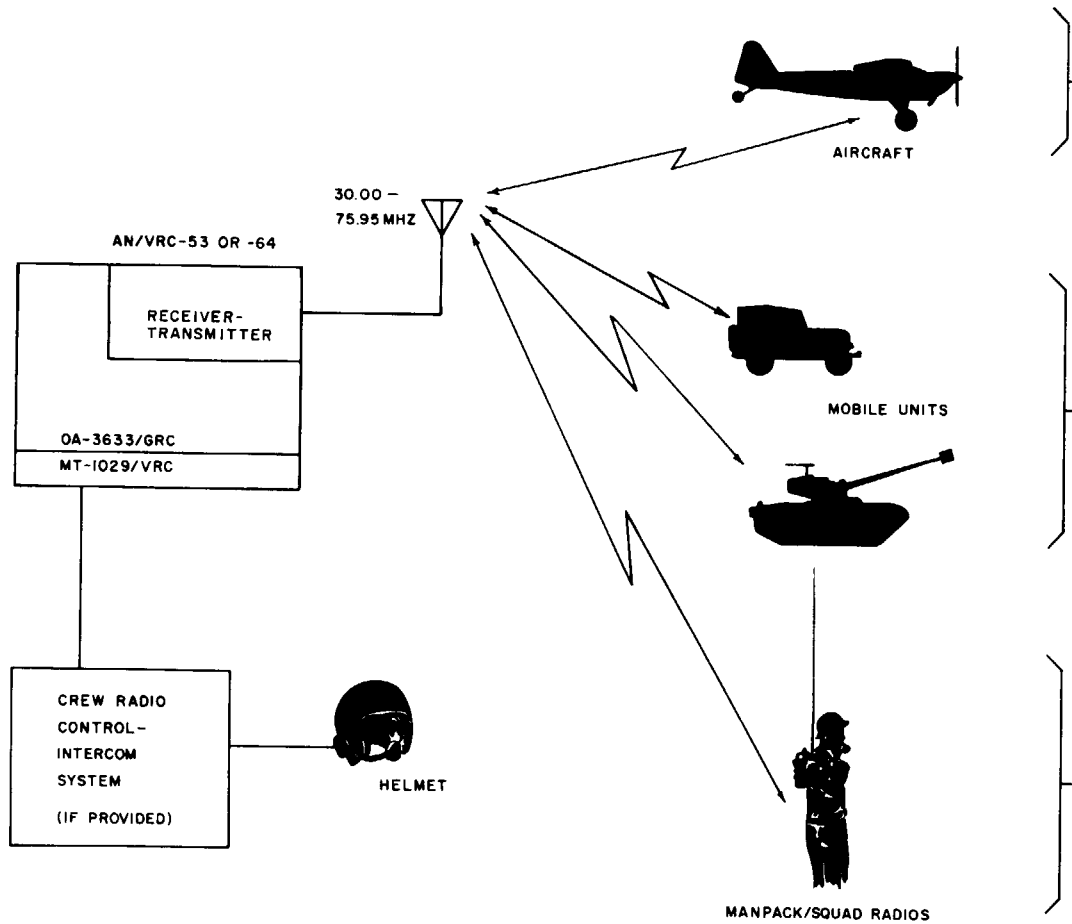

REPRESENTATIVE COMPATIBLE FM RADIOS:

AN/ARC-44 (MODIFIED), -45, -54;
 AN/ARC-114,-131;
 AN/ASC-10,-11,-15;
 ETC.

AN/VRC-12, -45 THRU -49,-54,-55;
 AN/GRC-3 THRU -8;
 AN/VRC-9, -10, -14, -15;
 AN/VRQ-2, -3;

AN/FSQ-75
 AN/VRC-53,-64;
 AN/GRC-125,-160,-163;
 AN/TSC-61A;
 AN/TSQ-70A,-71A;
 ETC.

AN/PRC-25, -77;
 AN/PRC-6, -9, -10, -28;
 AN/PRT-4; AN/PRR-9;
 MAN-PACK OF AN/GRC-125,
 AN/GRC-160
 ETC.

EL5820-498-12-C5-TM-3

Figure 1-5. Typical radio sets compatible with receiver-transmitters in AN/VRC-53, AN/VRC-64, AN/GRC-125, and AN/GRC-160.

e. A pressure relief valve is installed in CY-2562/PRC-25 (fig. 2-6) to vent hydrogen gas (a byproduct of magnesium battery BA-4386/U) from CY-2562, and thus prevent gas accumulation in receiver-transmitter when it is used for man-pack operation (para 2-6a). The valve is provided in new equipment and in used equipment per MWO 11-5800-211-30-1 (13 Sep 72). The valve is required to prevent injury to personnel and damage to the receiver-transmitter if the gas explodes inside the rcvr-xmtr case.

1-9. Description of Amplifier-Power Supply Groups OA-3633/GRC and OA-3633A/GRC (Fig. 1-7.)

a. The OA-3633/GRC consists of Amplifier-Power Supply AM-2060/GRC and Cable Assembly, Special Purpose, Electrical

CX-4655/GRC. The OA-3633A/GRC consists of AM-2060A/GRC and CX-4655/GRC. The CX-4655/GRC provides interconnection between the amplifier-power supply and the installed receiver-transmitter for the passage of dc power, audio signals, and control signals.

b. The amplifier-power supply provides operating voltages for the receiver-transmitter and contains a loudspeaker for hearing received radio signals. It also provides passage of audio and keying signals between the receiver-transmitter and associated radio/intercom system of vehicle crewmembers.

c. The AM-2060A/GRC is identical with the AM-2060/GRC except that the A model has filter capacitors C8 and C9 inside the equipment and a rubber boot on the front panel SPKR switch.

d. The amplifier-power supply is a one-piece

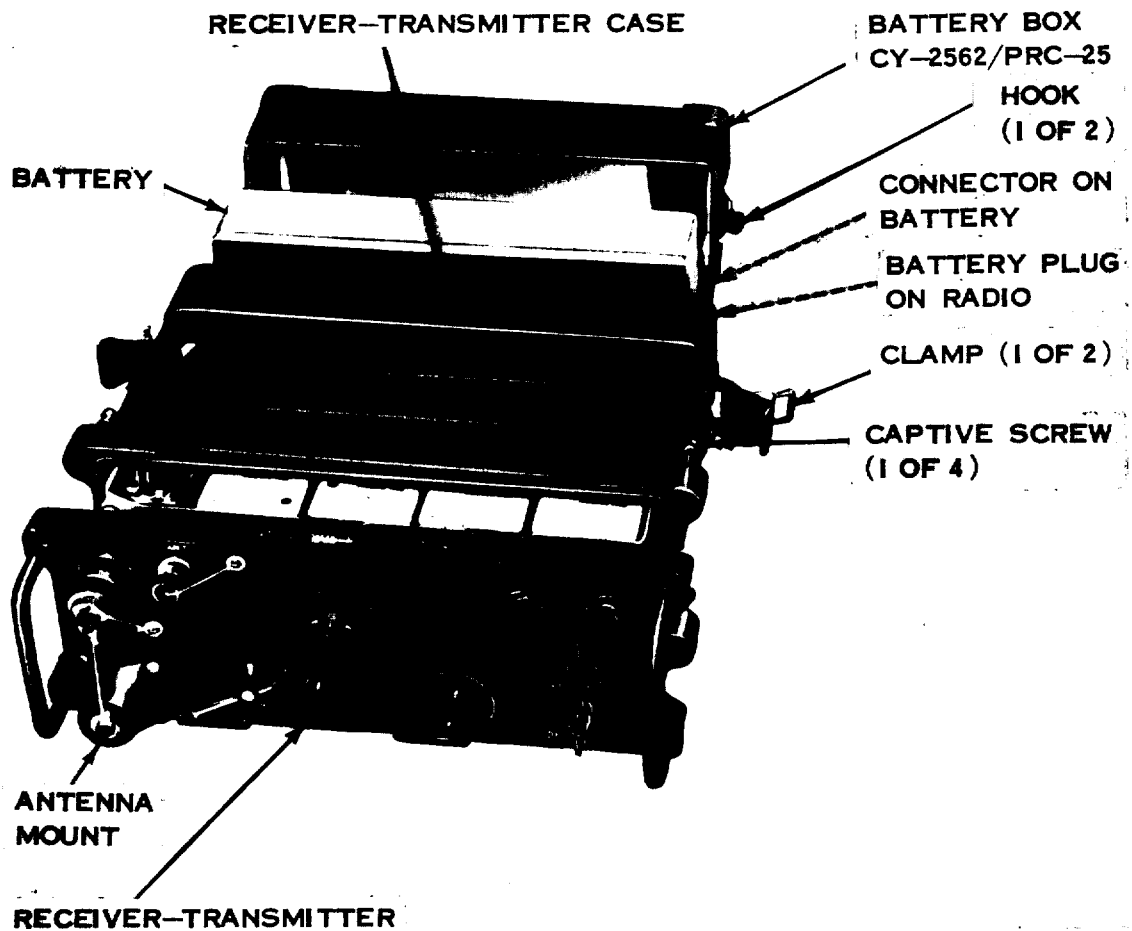

EL 5820-498-12-C5-TM-2

Figure 1-6. Receiver-transmitter with battery.

cast aluminum housing containing an internally mounted plug-in module, operating controls, connectors, and a loudspeaker. All operating controls are on the front of the unit.

e. An access plate, attached with six mounting screws, can be removed to provide access to the internally mounted plug-in module and components. Two mounting clamps at the front of the unit and a mounting plate at the rear attach the receiver-transmitter securely to the amplifier-power supply. Two slides allow easy insertion of the receiver-transmitter, and a bumper plate at the rear of the base assembly provides cushioning.

f. A power input connector which distributes power, control, and signal voltages between the amplifier-power supply and other equipment of the radio set system, and antenna control connector, cable clips for storing the CX-4655/GRC when not in use, and two guide pinholes to aid in holding the amplifier-power supply to the MT-1029/VRC, are located at the rear of the unit.

**1-10. Description of Mounting
MT-1029/VRC
(fig. 1-8)**

a. The MT-1029/VRC is a mounting for the amplifier-power supply. Five resilient mounts, formed of a stainless steel mesh, act as shock absorbers. Five screws inserted through the resilient mounts hold the top tray to the mounting plate (lower portion). Two copper bonding straps connected between the top tray and mounting plate insure a good ground connection. Two clamps lock the amplifier-power supply to the top tray. Two guide pins aid in holding the amplifier-power supply to the MT-1029/VRC.

b. The MT-1029/VRC contains a gasket-sealed junction box with connectors to provide distribution of power, control, and signal voltages between the "amplifier-power supply and other equipment in the radio set system. The connector on the front of the junction box mates with a connector at the rear of the amplifier-power supply. Three additional connectors on the bottom of the junction box provide connection of the system power and control cables.

**1-11. Description of Antenna AT-912/VRC
(fig. 1-9)**

a. The antenna is mounted on vehicles. Two antenna elements are mounted on the matching unit which contains antenna tuning networks for 10 frequency bands. The proper network is automatically selected by the tuning circuits of the receiver-transmitter to which it is connected. The antenna elements are made of rigid fiberglass in which a basket weave radiating metal is imbedded. Assembled, the antenna elements are 9 1/2 feet long.

b. The MX-2799/VRC is attached to the vehicle. The AB-719/VRC is attached to the end or the side of the MX-2799/VRC. The spring section of the AB-719/VRC permits the installed antenna elements to bend without breaking.

c. Receptacles for the control cable and antenna cable are located on one end of the MX-2799/VRC and are protected by a bar.

d. RF energy is transferred to and from the spring-loaded contact in the AT-1096/VRC through the contact on the top of the spring on the AB-719/VRC and the two-conductor lead to the BNC receptacle of the MX-2799/VRC.

**1-12. Description of Antenna
AS-1729/VRC
(fig. 1-10)**

a. The antenna is mounted on vehicles. Two antenna elements are mounted on the matching unit which contains antenna tuning networks for 10 frequency bands. The proper network is automatically selected by the tuning circuits of the receiver-transmitter to which it is connected. The antenna elements are made of rigid fiberglass in which a basket weave radiating metal is imbedded. Assembled, the antenna elements are 9 1/2 feet long.

b. The MX-6707/VRC is attached to the vehicle. The spring section on one end permits the installed antenna elements to bend without breaking. Receptacles for the control cable and antenna cable and a band control are located on the other end. The receptacles and the

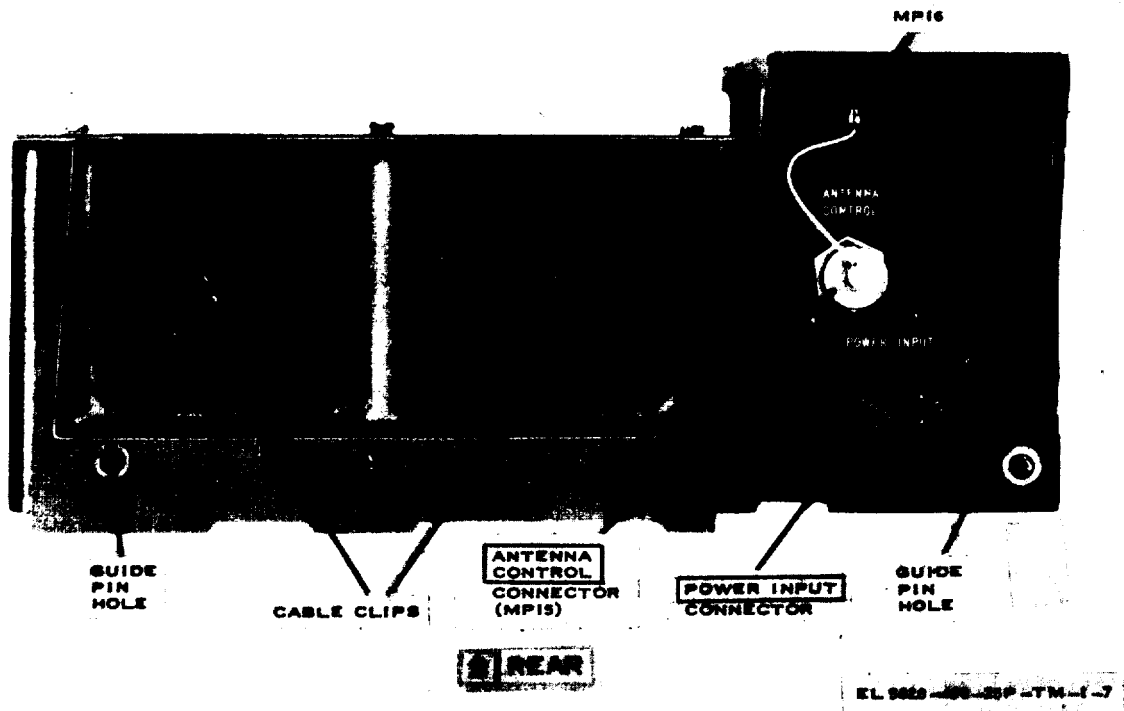
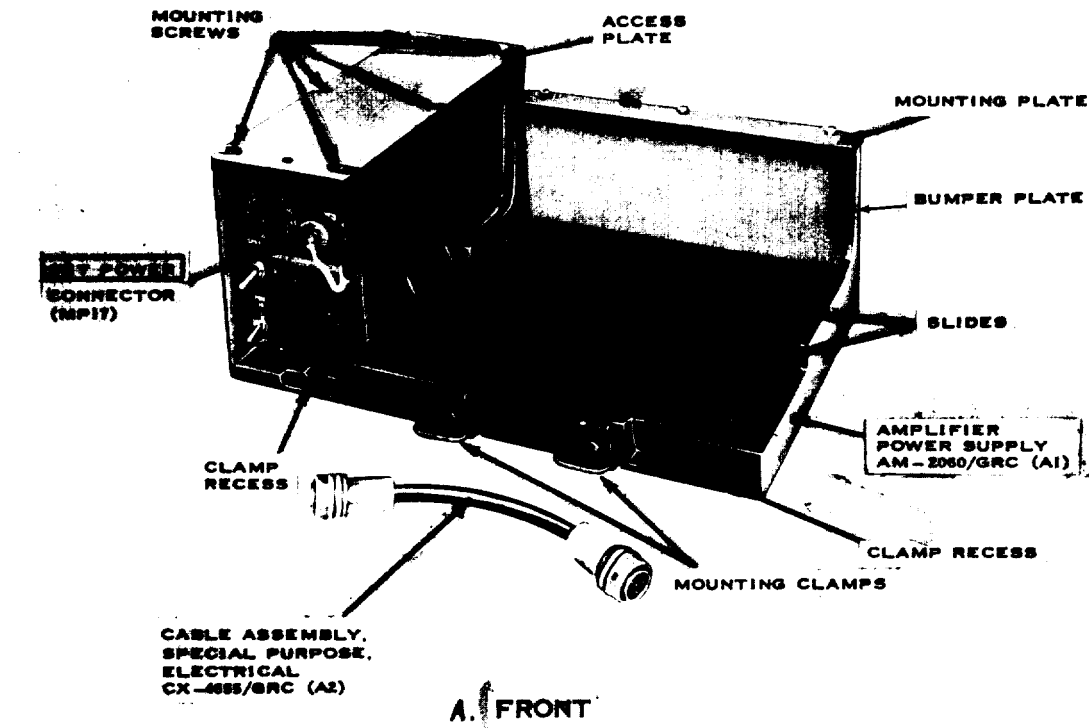

Figure 1-7. Amplifier-Power Supply Group OA-3633/GRC, front and rear views.

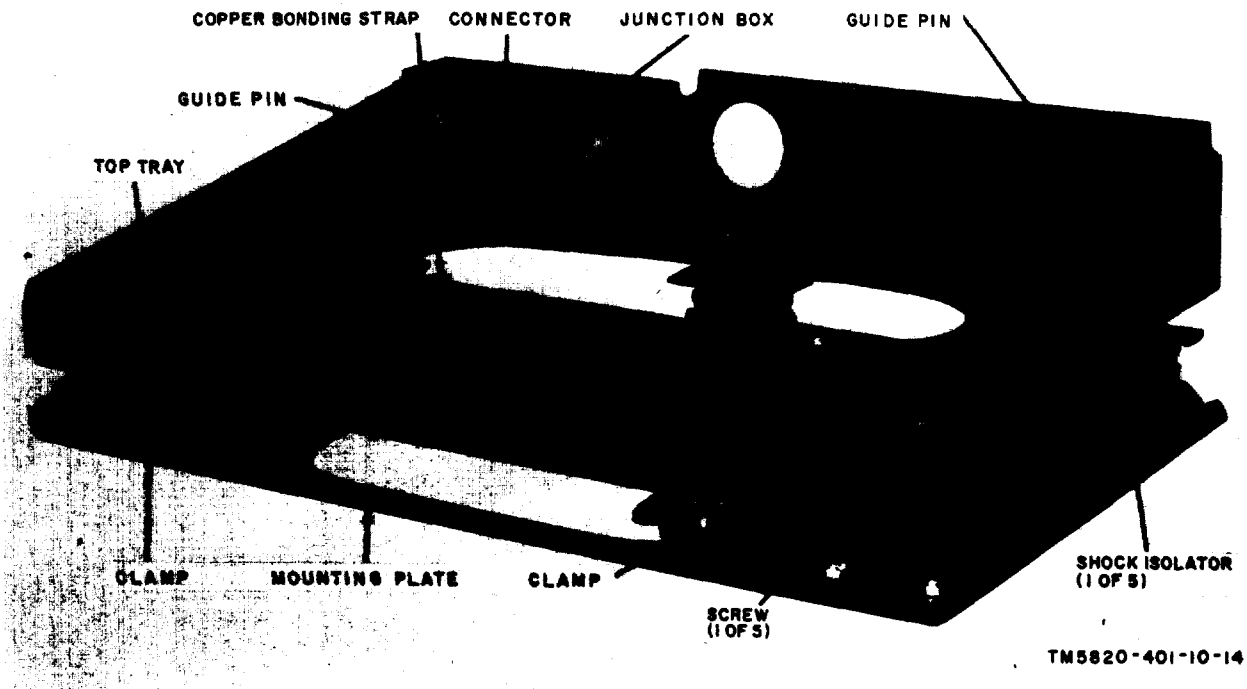

Figure 1-8. Mounting MT-1029/VRC.

switch are protected by three studs; one stud is threaded so that it can be used for securing a ground strap. The band control is automatically moved by the tuning circuits of the associated receiver-transmitter; it can also be moved manually.

c. Operation, maintenance, and repair parts for the AS-1729/VRC are contained in TM 11-5985-262-15.

d. A spring-loaded contact on the bottom of the AS-1730/VRC transfers RF energy to and from the contact at the top of the spring section of the MX-6707/VRC.

1-13. Description of Cables Used With Radio Sets

a. *Cable Assembly, Power, Electrical CX-4720/VRC.* The CX-4720/VRC (fig. 1-11) connects the MT-1029/VRC to the vehicular electrical system. It is usually 10 feet long and has a four-terminal female connector at one end and two leads at the other.

b. *Cable Assembly, Radio Frequency CG-1773/U.* The CG-1773/U (fig. 1-12) is used to interconnect the radiofrequency (rf) signal between the MX-2799/VRC or MX-6707/VRC of the antenna and the receiver-transmitter. It has Connector, Plug, Electrical UG-88E/U at one end and Connector, Plug, Electrical UG-913A/U at the other,

c. *Cable Assembly, Special Purpose, Electrical CX-4722/VRC.* The CX-4722/VRC (fig. 1-12) is used to interconnect the control power from the amplifier-power supply to the MX-2799/VRC or MX-6707/VRC. It has a 12-terminal female connector at one end and a 12-terminal male connector at the other.

d. *Cable Assembly, Power, Electrical CX-4721/VRC.* The CX-4721/VRC (fig. 1-11) may be used to interconnect the vehicular electrical system from one MT-1029/VRC to another MT-1029/VRC. It is usually from 2 to 4 feet long and has a four-terminal female connector on one end and four-terminal male connector on the other end.

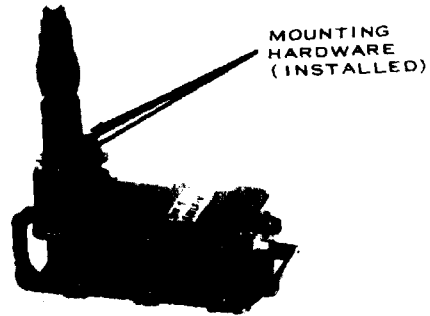

A. HORIZONTAL INSTALLATION OF MX-2799/VRC



B. VERTICAL INSTALLATION OF MX-2799/VRC

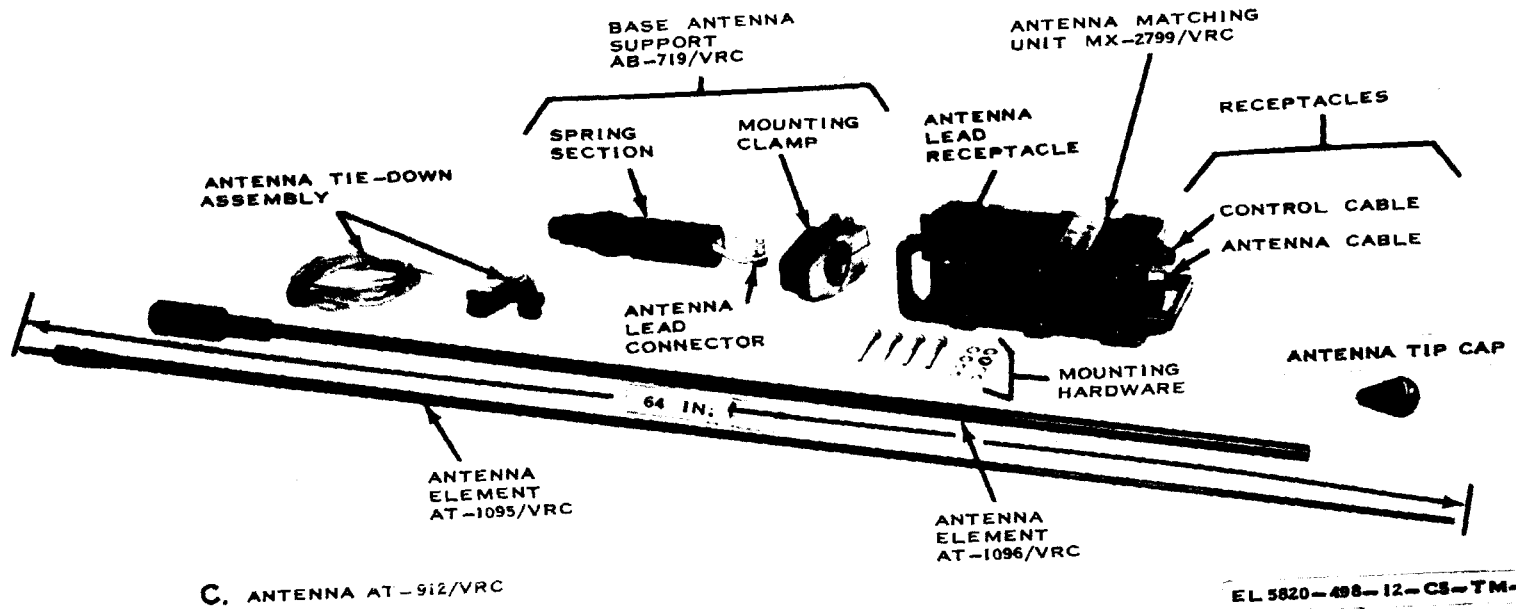

C. ANTENNA AT-912/VRC

EL 5820-498-12-CS-TM-7

Figure 1-9. Antenna AT-912/VRC components.

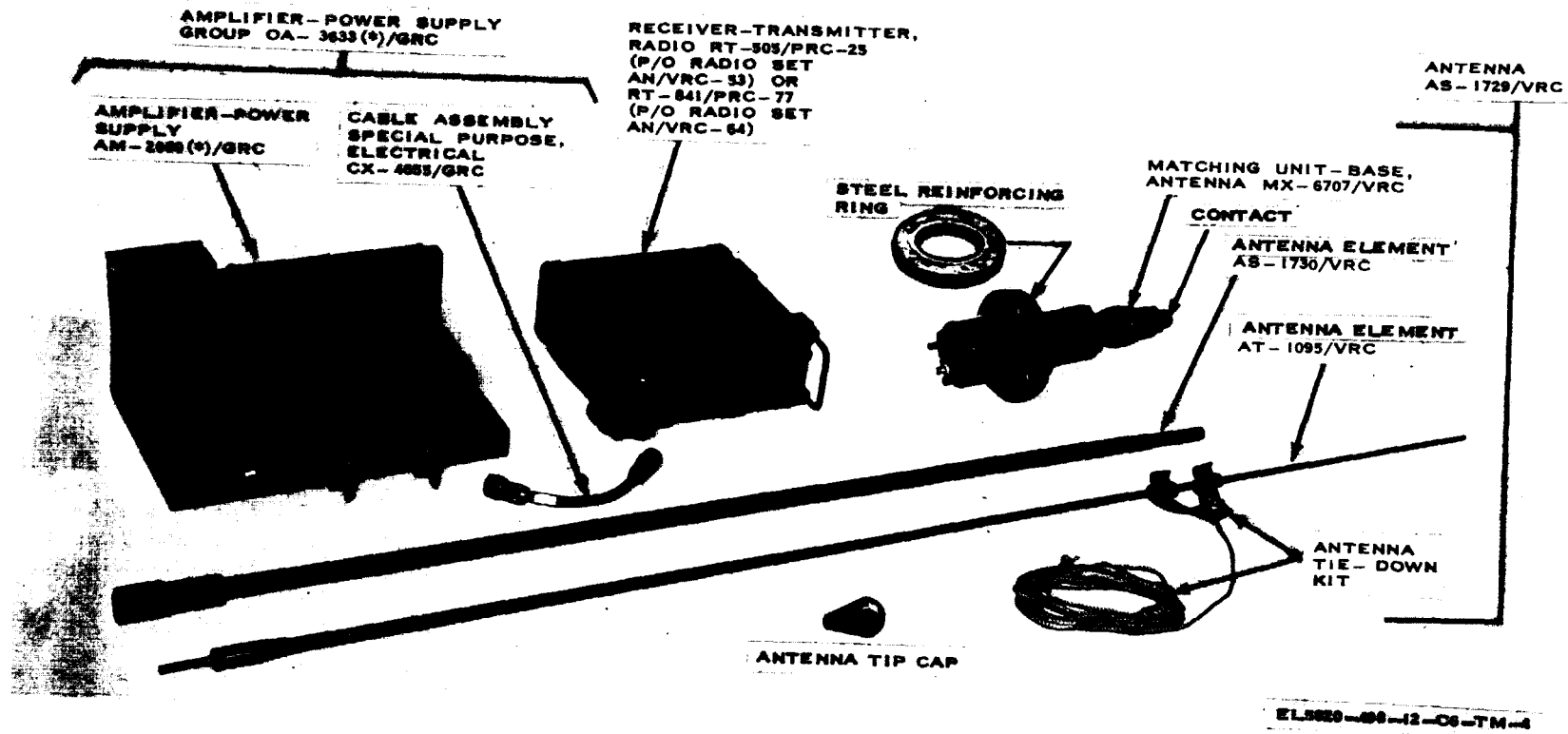
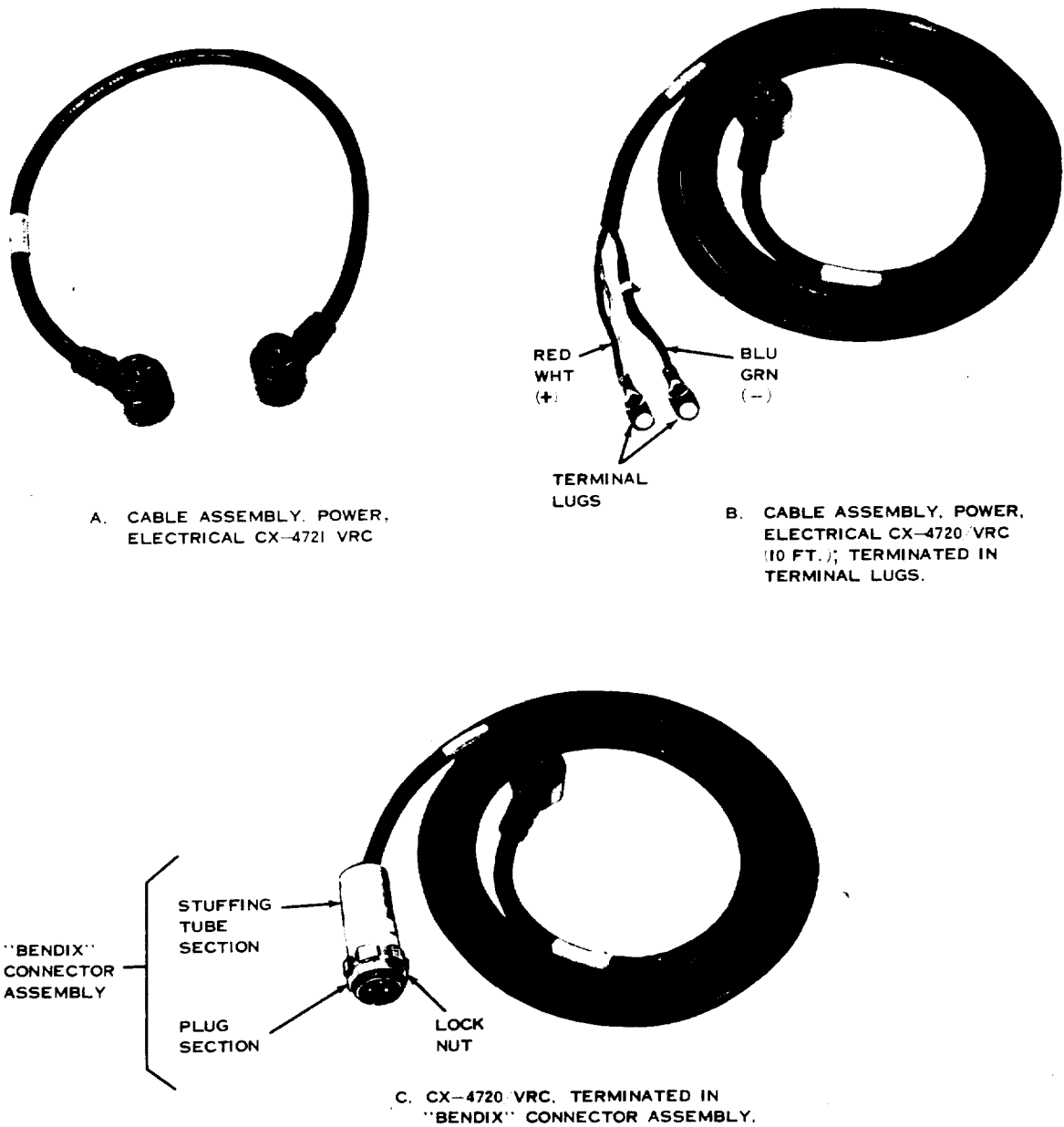

Figure 1-10. Components of AN/VRC-53 and AN/VRC-64.



EL 5820-401-12-TM-65

Figure 1-11. Cable Assembly, Power, Electrical CX-4721/VRC; and Cable Assembly, Power, Electrical CX-4720/VRC, terminated in terminal lugs and Bendix connector assembly.

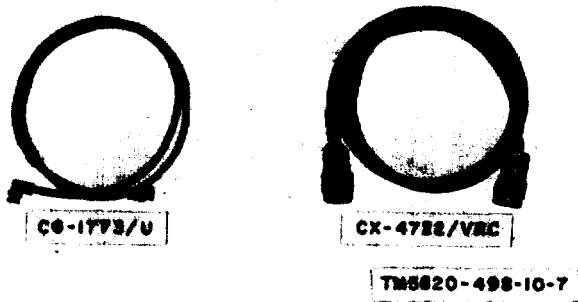

Figure 1-12. Cable Assembly, Radio Frequency CG-1773/U, and Cable Assembly, Special purpose, Electrical CX-4722/VRC.

1-14. Description of the Man-Pack Components of Radio Sets AN/GRC-125 and AN/GRC-160 (fig. 1-13)

Radio Set AN/PRC-25 is the man-pack component of the AN/GRC-125; Radio Set AN/PRC-77 is the man-pack component of the AN/GRC-160. For man-pack operation, the receiver-transmitter is removed from the amplifier-power supply and installed in the pack frame on the user (fig. 2-5). The components of the AN/PRC-25 and AN/PRC-77 are identical except that the RT-505/PRC-25 is part of the AN/PRC-25 and the RT-841/PRC-77 is part of the AN/PRC-77.

a. *Antenna AT-892/PRC-25.* The AT-892/PRC-25 is a one-section, 3-foot, whip antenna. A spring at its base allows positioning the antenna to keep it in a vertical position, no matter what the position of the receiver-transmitter. This antenna is used for general short-range service. It is made of steel tape and can be folded for storage.

b. *Antenna AT-271A/PRM.* The AT-271A/PRC is composed of six sections; each section fits into the end of a wider section. A stainless steel, plastic-covered cable (or braided plastic cord) under spring tension is threaded through the sections to keep them together in operating condition. When folded, the cable keeps the sections together as a group, thereby preventing the loss of individual sections.

Spring tension is provided by a spiral spring in the base section. The antenna is used when maximum range is required. An antenna tip cap installed on the tip of the antenna provides protection for personnel.

c. *Support, Antenna AB-591/PRC-25.* The AB-591/PRC-25 is a rigid tubular support for the AB-271A/PRC.

d. *Pack Frame LC-2.*

(1) The pack frame is used to carry the receiver-transmitter on the users back (fig. 2-5). The receiver-transmitter is strapped to the pack frame (fig. 2-4) and the CW-503/PRC-25 is clipped to one side to carry the unused antenna and the hand set. The combat belt of the user is also attached to the pack frame.

(2) The body of the LC-2 pack frame is made of metal and the straps are of webbed cotton material. The pack frame is provided with a metal case which is used to mount the receiver-transmitter.

e. *Bag, Cotton Duck CW-503/PRC-25.* The CW-503/PRC-25 is sectionalized into several pockets which are used to stow the two antennas, the antenna support, and the handset.

f. *Handsets H-189/GR, H-250/U, and H-138(*)/U.* The handsets are used with the receiver-transmitters for talking and listening. Each handset has a push-to-talk switch, dynamic microphone element, and receiver element. The retractile cord is terminated in a five-pin connector.

(1) The H-189/GR (B, fig. 1-14) is more rugged than the H-138(*)/U and does not have a noise-canceling microphone.

(2) The H-138(*)/U microphone section has two elements, each under a separate opening. When the user speaks into one opening, the other opening electrically cancels or reduces outside noise and thus prevents its transmission along with the user's voice.

(3) The H-250/U (A, fig. 1-14) is a rugged handset that is lighter than the H-189/GR and is provided with a plastic five-pin connector.

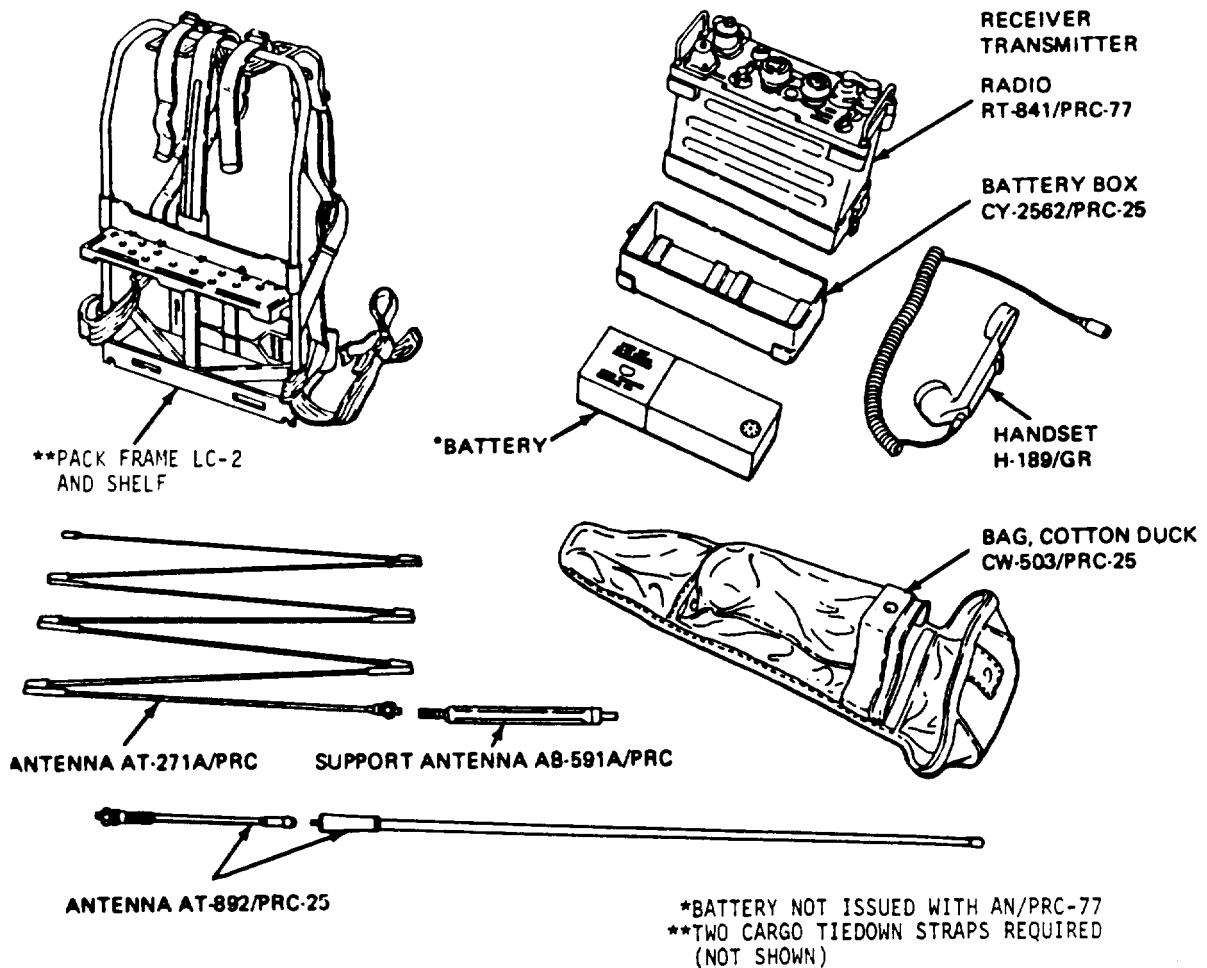

EL80R001

Figure 1-13. Man-pack components AN/GRC-125 and AN/GRC-160 (the receiver-transmitter shown is also used in the vehicular operation of the radio set).

1-15. Operating Power Requirements for Radio Sets

a. *Vehicular Operation.* A 24-volt direct current (dc) power source, such as the vehicular electrical system, is required to supply operating power for the amplifier-power supply which in turn, converts the 24 volts to 3 and 15 volts for operating the receiver-transmitter. The radio/intercom system (AN/VIC-1(V)) also uses the 24-volt dc vehicular system for power.

b. *Man-Pack Operation.* In the man-pack operation of the AN/GRC-125 and AN/GRC-160, the receiver-transmitter is removed from amplifier-power supply and installed in the pack frame on the user's back. To power the receiver-transmitter under this situation, dry cell batteries are required. Typical batteries are described below.

(1) Battery, Dry BA-4386/U is a magnesium cell battery that operates the equipment approximately 20 to 30 hours. Battery, Dry BA-5598/U is a lithium battery that will operate the radio approximately 45 hours. Physically, BA-5598/U is 1/2 the length of BA-4386/U allowing 2 BA-5598/U batteries to be carried in Battery Box CY-2562/PRC-25. Battery, Dry BA-4386/U supplies 3 to 15 volts to operate the receiver-transmitters. Both voltages are used by the RT-505/PRC-25; only 15 volts are used by the RT-841/PRC-77.

(2) Lithium battery BA-5598/U, for arctic use, is operable only with the AN/PRC-77. This battery has replaced Battery, Dry BA-398/U.

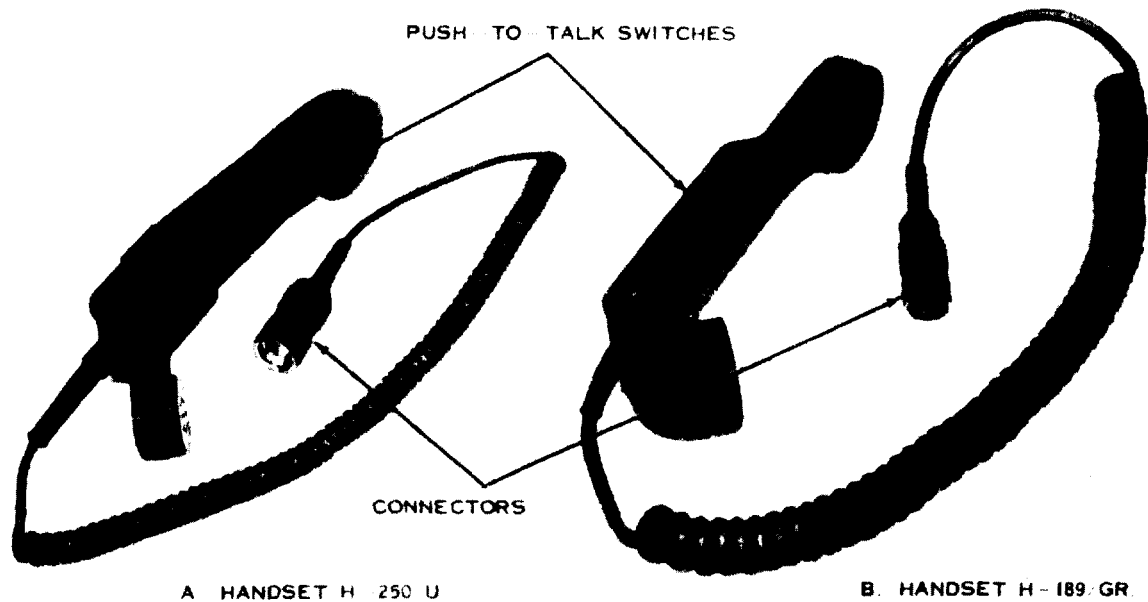

EL 5820 - 401 - 12 - TM -

Figure 1-14. Handsets H-250/U and H-189/GR.

c. *Fixed Station or Bench Testing Operation.* For fixed station operation or bench testing, dc power may be obtained from a 25-volt power supply, such as Power Supply PP-2953(*)/U (TM 11-6130-233-12). (PP-2953(*)/U represents all models of the power supply.)

(1) The PP-2953(*)/U converts 115 volts ac (50-60 cps) or 400 cps) at 4 amperes or 230 volts ac (50-50 cps) at 2 amperes into a fixed and regulated 25.2-volt dc output at 10 amperes, maximum.

(2) Two amplifier-power supplies may be connected to the PP-2953(*)/U. The dc power is applied to the amplifier-power supplies through MT-1029/VRC's that

are interconnected with Cable Assembly, Power, Electrical CX-4721/VRC.

(3) In areas in which the ac power source varies beyond the ac input capabilities of the PP-2953(*)/U, Variable Power Transformer TF-523/U (TM 11-5950-212-12) may be used between the ac power source and the PP-2953(*)/U. The TF-523/U operates between 100- and 240-volt ac (60 to 400 cps) input and can be adjusted between 0- and 280-volt ac output at 8 amperes, maximum. The TF-523/U is also provided with the CX-4721/VRC to enable two MT-1029/VRC's to be interconnected ((2) above).

CHAPTER 2 INSTALLATION

Section I. SERVICE UPON RECEIPT OF EQUIPMENT

2-1. General

This chapter covers unpacking and installation of the radio sets and the amplifier-power supply. The operating instructions for these equipments are contained in chapter 3.

2-2. Unpacking

a. Packaging Data. When packed for oversea shipment, the radio set is cushioned on all sides. The accessories are packed in one fiberboard container. These items are then placed within a water-resistant, fib-

erboard container, with all seams and joints sealed with waterproof, pressure-sensitive tape. The packaged set is then placed within a wooden packing case. When packed for domestic shipment, the methods applied may vary, depending on the supply course. The wooden packing case may not be used. A typical shipping box and its contents are shown in figure 2-1. The wooden packing case is 27¾ inches long, 20 inches wide, and 20¼ inches deep. It has a volume of 6.50 cubic feet and weighs 130 pounds when packed for shipment.

b. Dimensions. Dimensions of the components of the radio set are shown in the following chart.

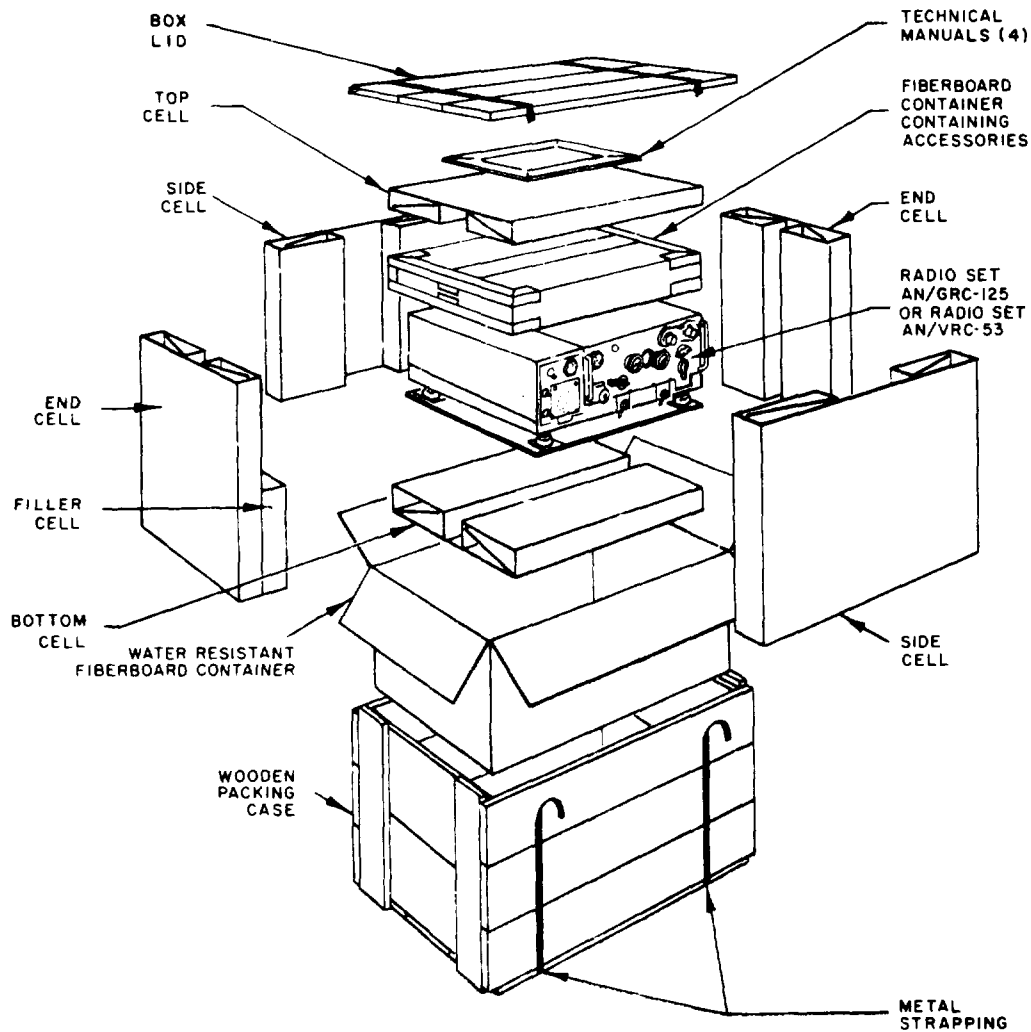

Figure 2-1. Typical packaging.

Dimension (in)	Volume (cu ft)	Unit weight (lb)	Contents of box
6¼x12x 15	1,125	21	Amplifier-power supply. Receiver-transmitter.
4-1/16 x 11¼ x 11	495	13.5	
Total weight		33.5	

WARNING

Prevent personal injury when applying or removing steel strapping by wearing heavy gloves and a protective face shield. Do not handle packing cartons by the steel strapping.

c. *Removing Contents.* When unpacking equipment that is packed in a wooden packing case (fig. 2-1) perform the procedures given in (1) through (6) below. When unpacking equipment that is packed in shipping containers, omit the procedures given in (1), (2), and (3) below.

- (1) Cut and fold back the metal strapping.
- (2) Remove the nails from the top and one side of the box with a nailpuller. Remove the top and one side. Do not attempt to pry them off; the equipment may become damaged.
- (3) Remove the water-resistant fiberboard container.
- (4) Open the container and remove the technical manuals. Remove the top, side, and end cells.
- (5) Remove the fiberboard container in which the accessories are packed. Open the container and remove the accessories.
- (6) Remove the radio set.

2-3. Checking Unpacked Equipment

a. Inspect the equipment for damage incurred during shipment. If the equipment has been damaged, report the damage on SF 364 (para 1-3).

b. See that the equipment is complete as listed on the packing slip. If a packing slip is not available, check the equipment against the list of components (para 1-6). Report shortages on SF 364 per AR 735-11-2. Shortage of a minor assembly or part that does not affect proper functioning of the equipment should not prevent use of the equipment.

c. If the equipment has been used or reconditioned, see whether it has been changed by a modification work order (MWO). If the equipment has been modified, the MWO number will appear on the front panel near the nomenclature plate. Check to see whether the MWO number (if any) and appropriate notations concerning the modification have been entered in the equipment manual.

NOTE

Current MWO's applicable to the equipment are listed in DA Pam 25-30. ■

Section II. INSTALLATION

WARNING

Operator and maintenance personnel should be familiar with the requirements of TB 43-0129 before attempting installation or operation of the equipment covered in this manual. Failure to follow requirements of TB 43-0129 could result in injury or DEATH.

2-4. Tools and Test Equipment Required for Installation

No special test equipment is required for the installation of the radio sets.

2-5. Vehicular Installation

Installation of the radio sets includes mounting the MT-1029/VRC, Antenna AT-912/VRC or Antenna AS-1729/VRC, and system control boxes in the vehicle or crew-served weapon. Locate and mount the mounting, antenna, and system control boxes in accordance with the installation kit instructions for the vehicle or crew-served weapon in which the radio set is being installed. Refer to SB 11-131 for a list of available vehicular and general purpose installation kits and for the stock numbers of the kit components and installation instructions. See paragraph 1-6b for more particulars.

WARNING

Observe the precaution on warning label DA Label 132: WARNING: DO NOT START VEHICLE WHILE RADIO IS ON. The label, positioned in attention-arresting location is required in accordance with SB 11-624. Spray with lacquer or varnish to preserve the label.

CAUTION

Install labels on the cable connected to the vehicular battery. On wheeled vehicles, attach labels to the CX-4720/VRC (B, fig. 1-11). Attach the negative label (FSN 7690-477-3715) to the blue-green leads and the positive label (FSN 7690-477-3714) to the red-white leads. Use supporting line strap (FSN 5340-985-6630) to tie each label to the cable leads. See c(1) and (2) below for further details.

a. Mounting MT-1029/VRC Link Connections (fig. 2-2). After installing the MT-1029/VRC (fig. 1-8), make the appropriate link connection in the MT-1029/VRC junction box (fig. 2-2) as follows:

(1) Loosen the six captive screws on the top of the junction box and remove the cover.

(2) If the amplifier power supply is in a vehicular installation that is *without* an intercom system (AM-1780/VRC and crewmember control boxes), dc power is applied directly to the amplifier power supply and, in turn, to the receiver-transmitter after the amplifier power supply is turned on. Accordingly, the link in the MT-1029/VRC junction box is connected between the center terminal and right terminal E24. Tighten all link screws. ■

(3) If the amplifier power supply is in a vehicular installation that *includes* an intercom system (AM-1780/VRC and crewmember control boxes (fig. 2-3)), dc power is applied direct to the AM-1780/VRC and, in turn, to the amplifier power supply and the receiver-transmitter. Accordingly, the link in the MT-1029/VRC junction box is connected between the center terminal and the left terminal E22. Tighten all link screws.

(4) Replace and secure the cover on the MT-1029/VRC junction box. Be careful not to bend the extended terminal to which fuse F11 is attached. The extended terminals plug into terminals E21 and E24.

b. Adjustment of Amplifier, Audio Frequency AM-1780/VRC. Before operating the radio set, turn the INSTALLATION switch on the AM-1780/VRC to OTHER (fig. 3-2).

c. Cable Connections. After all the components of the radio set have been located and secured in place, interconnect the component and connect power to the equipment. A typical cabling diagram for a vehicular installation is shown in figure 2-3.

(1) In wheeled vehicles (such as Truck, 1/4-Ton, M151A1; Truck, 3/4-Ton, M37, etc.), the lugs on the radio power cable CX-4720/VRC (fig. 1-11) are connected to the bolts that hold the vehicle battery cables to the battery terminals. The red-white leads of the CX-4720/VRC are connected to the positive (+) battery terminal; the green-black leads are connected to the negative (-) battery terminal (fig. 2-3). To help identify the CX-4720/VRC leads for the vehicle drivers and maintenance

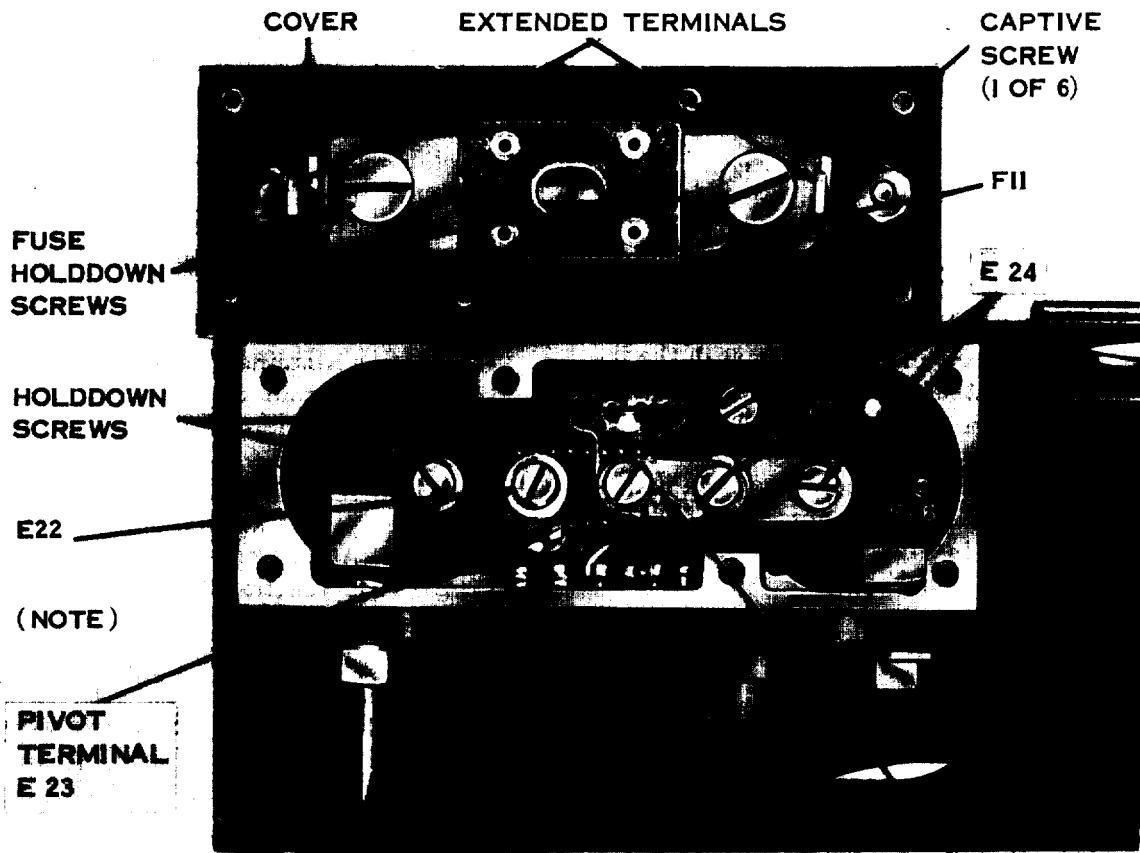

NOTE.
 DASHED LINES SHOW LINK POSITION
 WHEN D C POWER ON-OFF CONTROL
 IS PROVIDED BY AM 1780/VRC.

LINK POSITION
 FOR RADIO
 ON-OFF CONTROL
 OF DC POWER

EL 5820-498-12-C5-TM-4

Figure 2-2. Mounting MT-1029/VRC junction box, cover removed.

personnel, mark the red-white leads with a plus (+) and the green-black leads with a minus (-).

CAUTION

Connecting the CX-4720/VRC leads incorrectly to the vehicular battery may burn the contacts of receptacle J24 on the MT-1029/VRC (fig. 2-3)

and destroy parts inside the AM-2060/GRC.

(2) In tracked vehicles, the CX-4720/VRC (C, fig. 1-11) is soldered to a tubular connector which is screwed to a nearby power receptacle in the vehicle. The red-white wires (+) of the CX-4720/VRC are soldered to terminal A of the tubular connector (vehicle plus (+) and the green-black wires (-) of the

CX-4720/VRC are soldered to terminal B of the tubular connector (vehicle chassis).

Note

If the vehicle (tracked or wheeled) battery is removed and replaced, make sure that the radio power cable connections to the battery are correct. In vehicles, the *negative* terminal of the battery is *smaller* than the positive terminal; and the negative terminal is connected by a cable to the engine or vehicle chassis.

(3) For tracked vehicles, a transient-voltage suppressor is available; it is Electrical Transient Suppressor MX-7778/GRC. Its installation and maintenance is covered in TM 11-5915-223-12. It provides protection to the radio from transient voltages in the vehicular electrical system and in case of an overload or short in the radio equipment the circuit breaker in the MX-7778/GRC trips open. The MX-7778/GRC is mounted in a convenient place near the radio(s) in the tracked vehicle and is connected to a nearby electrical outlet. The radio power cable CX-4720/VRC is connected to a tubular connector ((2) above) which in turn is attached to the MX-7778/GRC. Two radio power cables can be connected to the MX-7778/GRC.

d. Installation of Amplifier-Power Supply on Mounting MT-1029/VRC (fig. 1-7 and 1-8).

(1) Loosen the clamps on the MT-1029/VRC.

(2) Set the amplifier-power supply on the MT-1029/VRC.

(3) Mate the POWER INPUT connector at the rear of the amplifier-power supply with the connector on the MT-1029/VRC junction box. Be sure that the guide pins on the MT-1029/VRC are aligned with the guide pin-holes on the amplifier-power supply.

(4) Push the amplifier-power supply back on the MT-1029/VRC.

(5) Engage the clamps on the MT-1029/VRC with the clamp recess on the amplifier-power supply. Tighten the clamps securely.

(6) Connect Cable Assembly, Special Purpose, Electrical CX-4722/VRC between the amplifier-power supply ANTENNA CONTROL connector and connector J552 on Antenna Matching Unit MX-2799/VRC, or connector J2 on Antenna Matching Unit MX-6707/VRC (fig. 2-3).

(a) Note that the ANTENNA CONTROL connector on the back of the amplifier-power supply (fig. 1-7) is female, and the one on the AT-912/VRC or AS-1729/VRC has the male pins. Connect the corresponding mating end of the CX-4722/VRC accordingly.

(b) Use caution when connecting the CX-4722/VRC connectors to the mating connectors. Improper mating damages the pins of the cable connector or the pins in the antenna matching units. First, line up the key in the receptacle with the slot in the cable connector. Then press in on the cable connector and turn the cable connector sleeve to lock the cable connector to the receptacle.

e. Installation of Receiver-Transmitter on Amplifier-Power Supply (fig. 1-7).

Note

Only if immediate man-pack operation is expected during the mission, install the battery in the receiver-transmitter before installing the receiver-transmitter on the amplifier-power supply.

(1) Loosen the screw-type mounting clamps on the front of the amplifier-power supply; they will drop slightly.

(2) Slide the receiver-transmitter into the amplifier-power supply until the bottom of the receiver-transmitter is flush with the bumper plate at the rear of the amplifier-power supply.

(3) Raise the screw-type mounting clamps until they engage the lips on the panel of the receiver-transmitter; tighten the screw-type mounting clamps.

(4) Remove the protective cap from the POWER connector on the panel of the receiver-transmitter.

(5) Connect Cable Assembly, Special Pur-

pose, Electrical CX-4655/GRC between the amplifier-power supply SET POWER connector and the receiver-transmitter POWER connector (fig. 2-3).

(6) Connect Cable Assembly, Radio Frequency CG-1773/U between the receiver-transmitter ANT connector and connector J551 on the MX-2799/VRC or connector J1 on the MX-6706/VRC (fig. 2-3).

NOTE

Test Set, RF Power TS-2609/U (TM 11-6625-1686-15) or TS-2609A/U (part of Test Set, RF Power AN/URM-182 (TM 11-6625-2718-14&P)) may be connected between the receiver-transmitter and the antenna cable (CG-1773/U) to measure the forwarded and reflected power (para 5-12). It has little effect on received radio signals.

j. *Vehicular Whip Antenna and Antenna Tiedown Kit.* The antenna matching unit (MX-6707/VRC of the AS-1729VRC, or MX-2799/VRC of the AT-912/VRC) are installed in accordance with the instruction applicable to the vehicle,

(1) General installation instructions for the AT-912/VRC are provided in TM 11-5820-401-12, and for the AS-1729/VRC in TM 11-5985-262-15. Refer to paragraph 4-1 for removal and installation instructions of the AT-912/VRC and AS-1729VRC (fig. 4-1).

CAUTION

TURN OFF THE RADIO

BEFORE connecting or disconnecting cables from the antenna matching unit.

BEFORE installing or removing the antenna elements.

(2) Tie down the antenna, if desired, using the inverted V method (fig. 2-7). Communication can still be effective with the antenna tied down but at reduced range.

WARNING

Remove the battery from the radio when the radios are not being used. This is required to prevent hydrogen gas (a by-product of the discharge action of the BA-4386/U) from accumulating. Personnel may be injured and equipment damaged if the gas explodes.

WARNING

A lithium battery is used in this equipment, and is potentially hazardous if misused or tampered with before, during, and after discharge. The following precautions must be strictly observed to prevent possible injury to personnel or damage to equipment.

DO NOT heat, incinerate, crush, puncture, disassemble, or otherwise mutilate the batteries.

DO NOT short circuit.

DO NOT recharge.

DO NOT bypass internal fuse or replace with a fuse of a different rating. Replacement fuses are packed two per every ten batteries.

DO NOT store in equipment during long periods of unuse in excess of 30 days.

TURN OFF the equipment immediately if you detect the battery compartment becoming unduly hot or rapidly increasing in temperature, hear battery venting (hissing sound), or smell irritating sulfur dioxide gas. Remove and dispose of the battery only after it is cool (30-60 minutes).

DO NOT use carbon dioxide extinguishers on exposed lithium metal fires. Flood the burning material with water or use graphite type compounds or extinguishers to extinguish burning lithium.

2-6. Assembly and Installation for Man-Pack Operation

a. Install the battery (fig. 2-6) as follows:

(1) Stand the receiver-transmitter on a level surface with the front panel facing downward.

(2) Release the two clamps and remove the CY-2562/PRC-25.

(3) Inspect the radio connector; if it is damaged or loose, the receiver-transmitter must be repaired. Tighten the pressure test screw and the locknut on the pressure relief valve.

(4) Position the new battery connector in line with the radio connector until the two connectors are mated.

(5) Install the CY-2562/PRC-25 on the receiver-transmitter case and tighten the two clamps.

b. Install the receiver-transmitter on Pack Frame LC-2 and metal shelf. Secure with two cargo tiedown straps (fig. 2-4 and 2-5) .

(1) When using the RT-505/PRC-25 of the AN/GRC-125, refer to TM 11-5820-398-12 for installation procedures.

(2) When using the RT-841/PRC-77 of the AN/GRC-160, refer to TM 11-5820-667-12 for installation procedures.

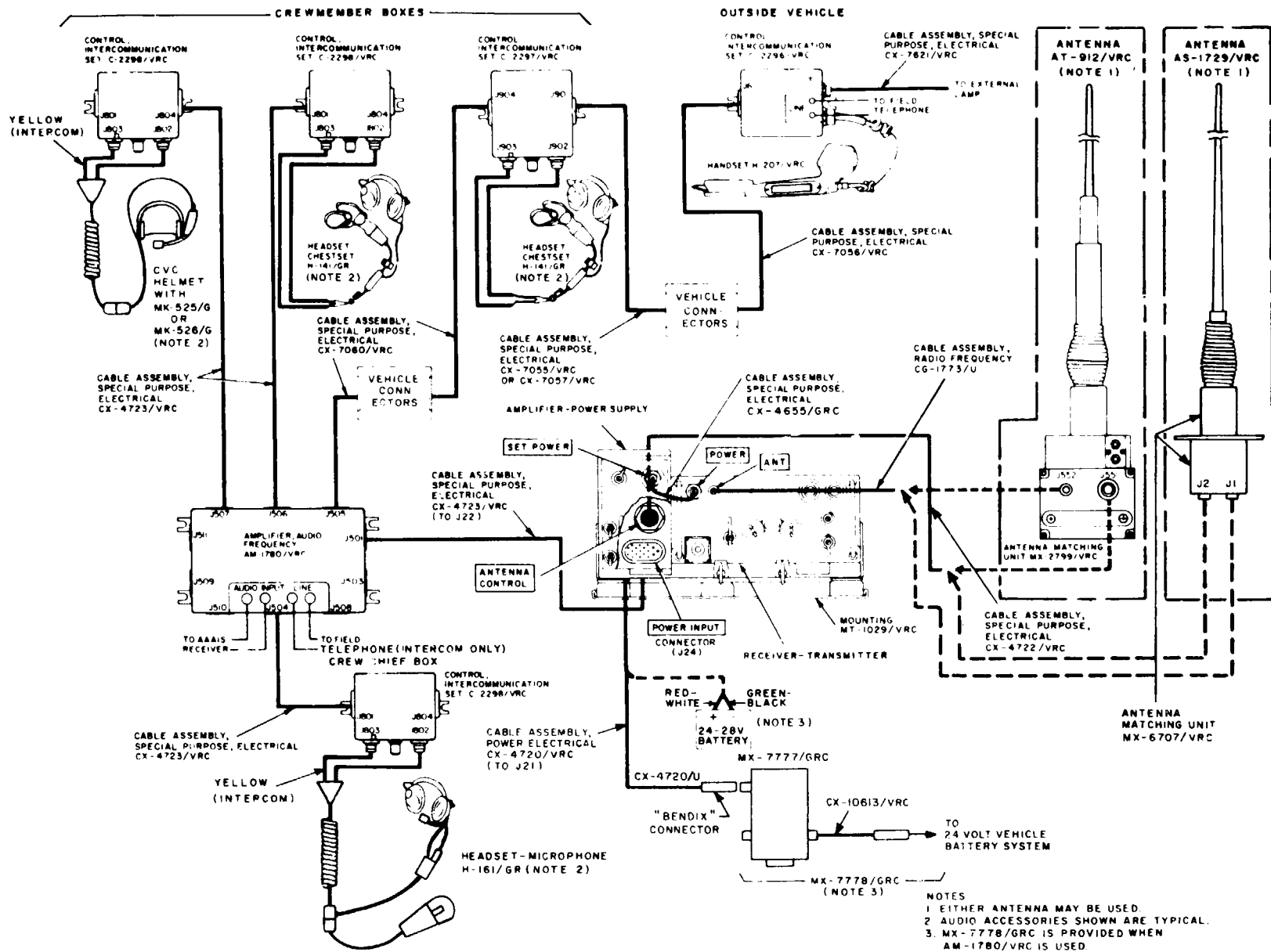

Figure 2-3. Cabling diagram of radio set (receiver-transmitter, OA-3633(*)/GRC, and antenna) with typical radio-intercom system (AM-1780/VRC, and crewmember control boxes).

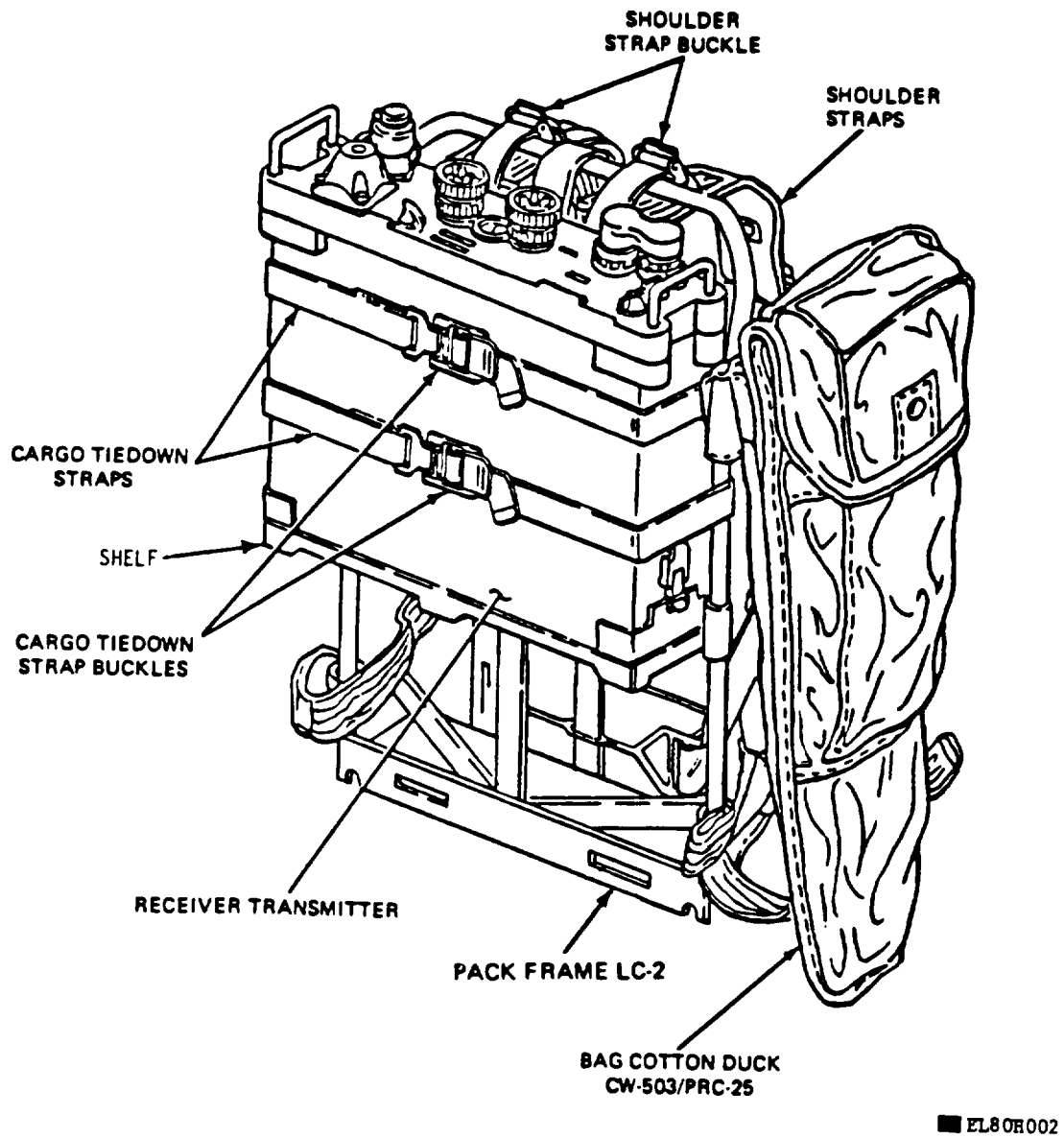
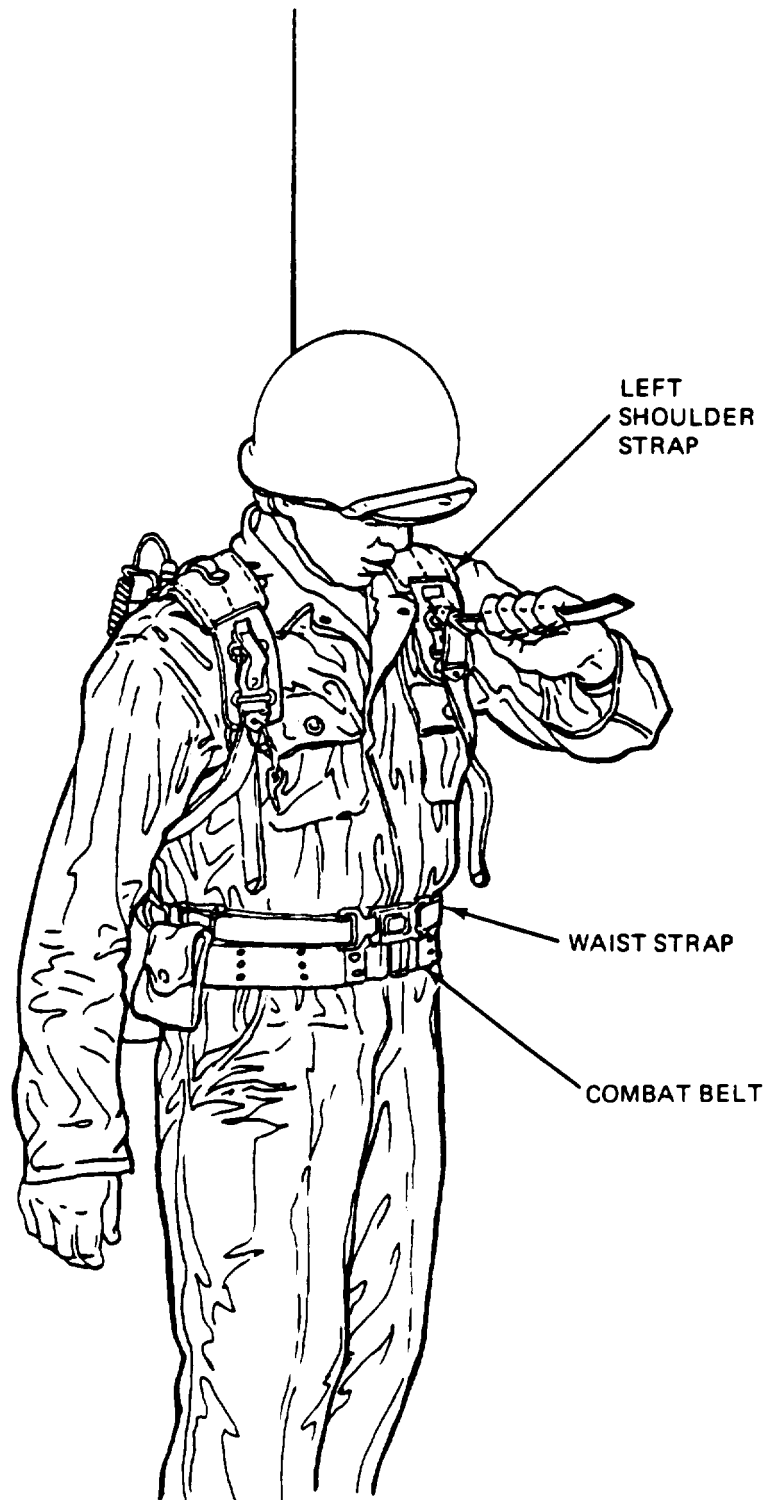
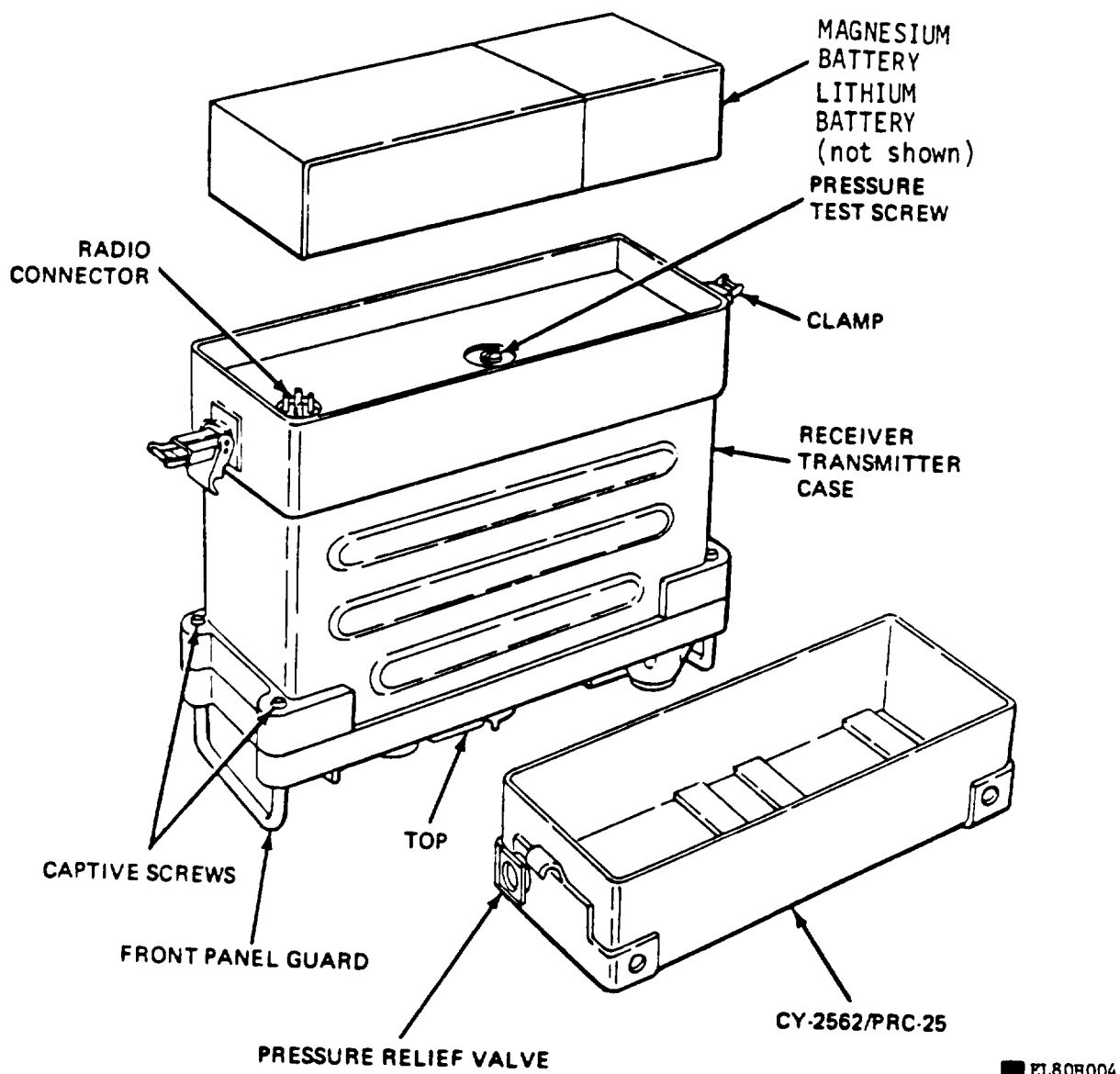

Figure 2-4. Installation of Receiver-Transmitter in LC-2 for man-pack operation.



■ EL80H003

■ *Figure 2-5 Strap arrangement of Pack Frame LC-2 for Man-pack Operation.*



■ *Figure 2-6. Installing battery in receiver-transmitter.*

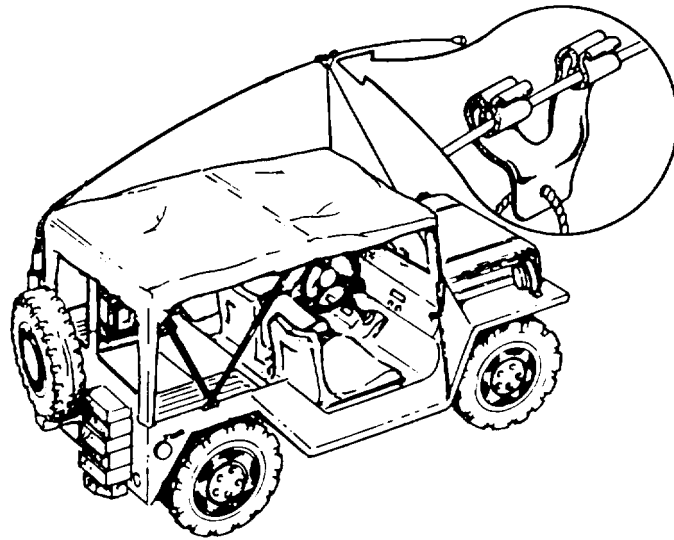

A. SIDE VIEW.

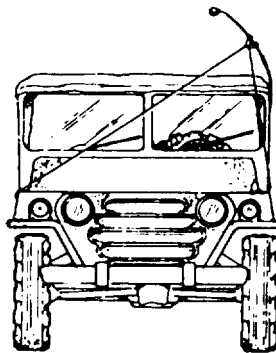

B. ONE ANTENNA.

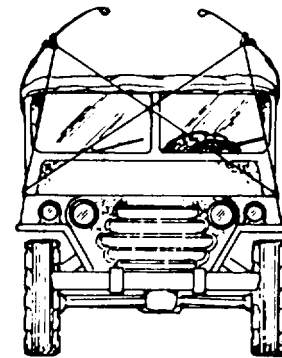

C. TWO ANTENNAS.

NOTE:

THE ANTENNA, ON THIS OR ANY VEHICLE, MAY BE PULLED DOWN SO THAT:

- A. THE TIP END IS ABOVE ANY PEDESTRIAN; AND
- B. IT WILL NOT SWING BEYOND THE SIDE OF THE VEHICLE

EL5985-262-15-C4-TM-9

Figure 2-7. Tying down antenna, applicable to any vehicle.

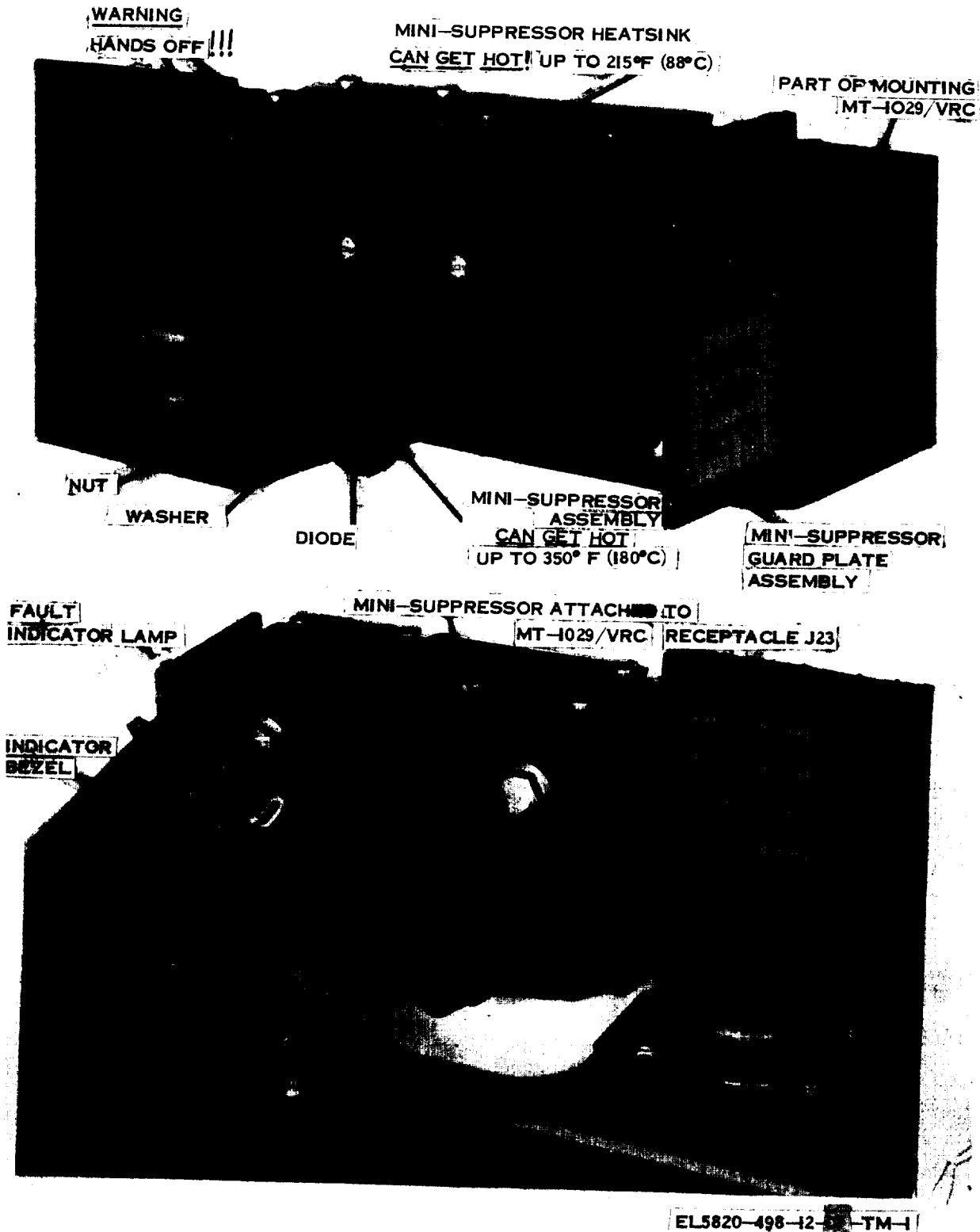

Figure 2-8. Mini-suppressor installed on MT-1029/VRC in some tank installation harnesses.

CHAPTER 3

OPERATING INSTRUCTIONS

Section I. OPERATOR'S CONTROLS, INDICATORS, AND CONNECTORS

Warning: Dangerous voltage exists at the antenna. Be careful not to touch the antenna while the radio set is transmitting.

Note. This section covers only the controls, indicators, and connectors used by the operator. Controls, indicators, and connectors used by maintenance personnel are covered in the instructions for the appropriate maintenance category.

3-1. Receiver-Transmitter, Radio RT-505/ PRC-25 and Radio RT-841/PRC-77, Controls, Indicators, and Connectors. (fig. 3-1)

Control, indicator, or connector	Function												
Function switch	<table border="1" style="width: 100%;"> <thead> <tr> <th>Sw pos</th> <th>Action</th> </tr> </thead> <tbody> <tr> <td>OFF</td> <td>Turns off power.</td> </tr> <tr> <td>ON</td> <td>Applies power.</td> </tr> <tr> <td>SQUELCH</td> <td>Applies power and reduces noise when no signal is being received.</td> </tr> <tr> <td>RETRANS</td> <td>Permits radio relay operation.</td> </tr> <tr> <td>LITE (spring loaded).</td> <td>When held in this position, lights REC-TRANS FREQUENCY dial.</td> </tr> </tbody> </table>	Sw pos	Action	OFF	Turns off power.	ON	Applies power.	SQUELCH	Applies power and reduces noise when no signal is being received.	RETRANS	Permits radio relay operation.	LITE (spring loaded).	When held in this position, lights REC-TRANS FREQUENCY dial.
Sw pos	Action												
OFF	Turns off power.												
ON	Applies power.												
SQUELCH	Applies power and reduces noise when no signal is being received.												
RETRANS	Permits radio relay operation.												
LITE (spring loaded).	When held in this position, lights REC-TRANS FREQUENCY dial.												
BAND switch	<table border="1" style="width: 100%;"> <tbody> <tr> <td>30-52 . . .</td> <td>Selects lower mc-frequency band.</td> </tr> <tr> <td>53-75 . . .</td> <td>selects higher mc-frequency band . .</td> </tr> </tbody> </table>	30-52 . . .	Selects lower mc-frequency band.	53-75 . . .	selects higher mc-frequency band . .								
30-52 . . .	Selects lower mc-frequency band.												
53-75 . . .	selects higher mc-frequency band . .												
REC-TRANS FREQUENCY dial Mc tuning control . .	Indicates operating frequency. Tunes in 1-me steps as indicated by REC-TRANS FREQUENCY dial.												
Kc tuning control . . .	Tunes in 50-kc steps es indicated by REC-TRANS FREQUENCY dial.												
PRESET controls . . .	Permit rapid tuning of two present frequencies.												
VOLUME control . . .	Varies receiver volume.												
AUDIO connectors . . .	Connection for audio accessories.												

Control, indicator, or connector	Function
ANT mount	Connection for Antenna AT-271A/PRC-25 or AT-892/PRC-25.
ANT connector	Connection for fixed or vehicular antenna.
POWER connector . . .	Connection for power from amplifier-power supply when receiver-transmitter is used as part of either radio set. When the receiver-transmitter is part of AN/PRC-25, and if the cover for the POWER connector is not in place, the AN/PRC-25 will not operate.

3-2. Amplifier-Power Supply AM-2060/ GRC, Controls and Connectors

Control or connector	Function
PWR switch*	Turns equipment on and off.
SPKR switch	Connects and disconnects the loudspeaker.
ANT. FREQ. CONTROL. ANTENNA CONTROL connector.	Selects proper loading for vehicle antenna Provides connection for Cable Assembly, Special Purpose, Electrical CX-4722/VRC to Antenna Matching Unit MX-2799/VRC or M X - 6707/VRC.
SET POWER connector.	Provides connection for Cable Assembly, Special Purpose, Electrical CX-4655/GRC to POWER connector on receiver-transmitter.

*PWR switch and circuit breaker trips with 4-amp overload.

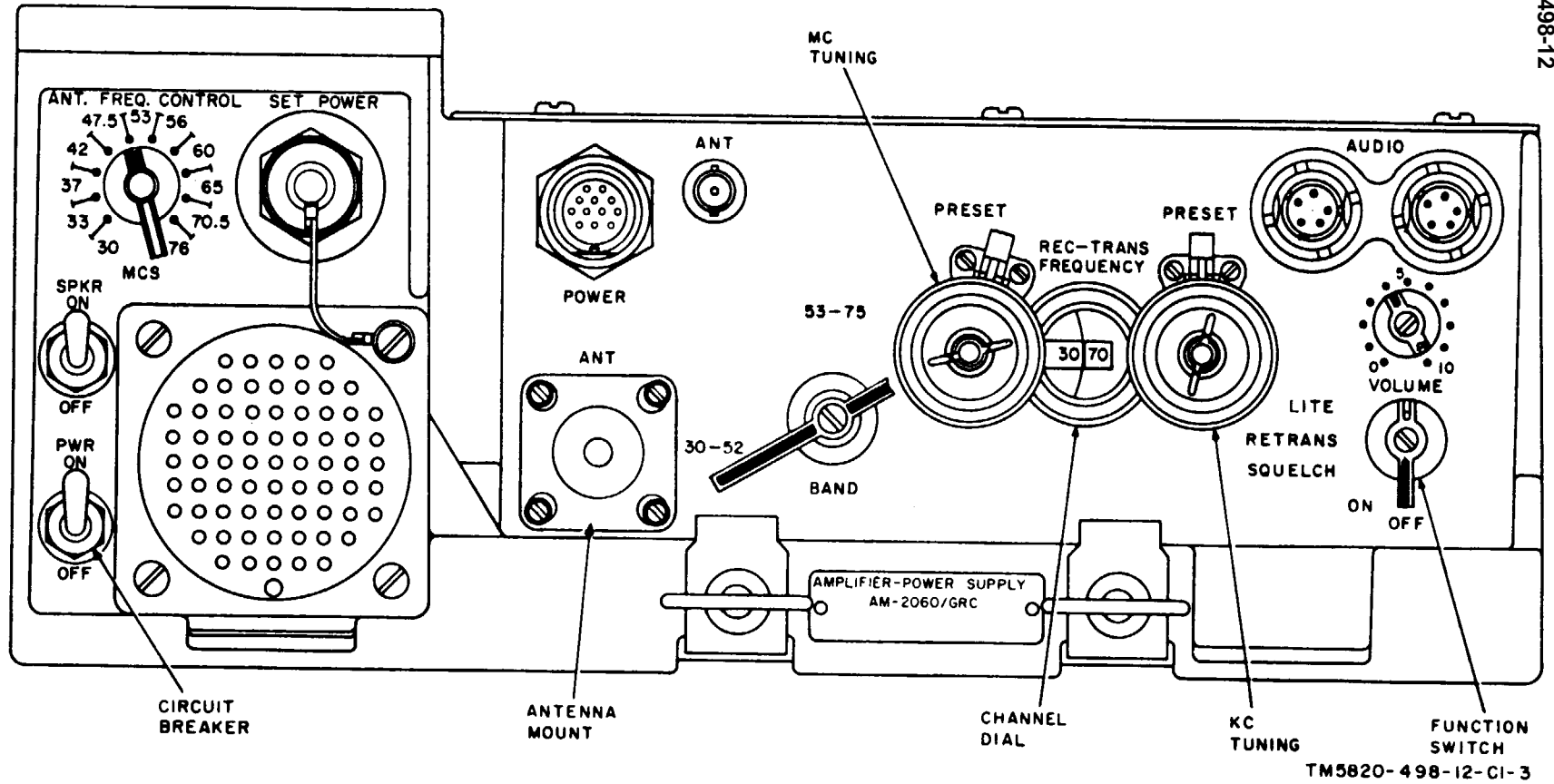

Figure 3-1. Amplifier-power supply and receiver-transmitter, controls, indicators, and connectors.

Control or connector	Function
POWER INPUT connector ^a .	Provides connections to Mounting MT-1029/VRC.

^aANTENNA CONTROL and POWER INPUT connectors are located on the rear of the AM-2060/GRC.

3-3. Amplifier, Audio Frequency AM-1780/VRC, Controls, Indicator, and Connectors (fig. 3-2)

Control, Indicator, or connector	Function								
MAIN PWR switch . .	<p>Three-position switch that controls intercom and radio set system power.</p> <table border="0"> <tr> <td style="padding-right: 20px;">Sw pos</td> <td>Action</td> </tr> <tr> <td>OFF</td> <td>Turns system power off.</td> </tr> <tr> <td>INT ONLY</td> <td>Turns on system power for intercom when INSTALLATION SWITCH is at INT ONLY.</td> </tr> <tr> <td>NORM</td> <td>Turns on system power for radio and intercom.</td> </tr> </table>	Sw pos	Action	OFF	Turns system power off.	INT ONLY	Turns on system power for intercom when INSTALLATION SWITCH is at INT ONLY.	NORM	Turns on system power for radio and intercom.
Sw pos	Action								
OFF	Turns system power off.								
INT ONLY	Turns on system power for intercom when INSTALLATION SWITCH is at INT ONLY.								
NORM	Turns on system power for radio and intercom.								
INT ACCENT switch	<p>Adjusts relative loudness of intercom and radio signals.</p> <table border="0"> <tr> <td style="padding-right: 20px;">Sw pos</td> <td>Action</td> </tr> <tr> <td>OFF</td> <td>Radio and intercom signals have same loudness.</td> </tr> <tr> <td>ON</td> <td>Intercom signals are louder than radio signals.</td> </tr> </table>	Sw pos	Action	OFF	Radio and intercom signals have same loudness.	ON	Intercom signals are louder than radio signals.		
Sw pos	Action								
OFF	Radio and intercom signals have same loudness.								
ON	Intercom signals are louder than radio signals.								
RADIO TRANS switch.	<p>Determines which crew boxes can control the RT-505/PRC-25.</p> <table border="0"> <tr> <td style="padding-right: 20px;">CDR + CREW</td> <td>Commander and crew boxes can control receiver-transmitter.</td> </tr> <tr> <td>CDR ONLY</td> <td>Only commander's box can control receiver-transmitter.</td> </tr> <tr> <td>LISTENING SILENCE</td> <td>Neither commander nor crewmembers can talk on</td> </tr> </table>	CDR + CREW	Commander and crew boxes can control receiver-transmitter.	CDR ONLY	Only commander's box can control receiver-transmitter.	LISTENING SILENCE	Neither commander nor crewmembers can talk on		
CDR + CREW	Commander and crew boxes can control receiver-transmitter.								
CDR ONLY	Only commander's box can control receiver-transmitter.								
LISTENING SILENCE	Neither commander nor crewmembers can talk on								

Control, Indicator, or connector	Function
POWER indicator ----	Indicates POWER CKT BKR is ON and power is applied.
POWER CKT BKR switch.	Controls power to AM-1780/VRC and microphones of audio accessories connected to C-2296/VRC, C-2297/VRC, and C-2298/VRC and provides overload protection.
AUDIO INPUT binding posts.	Connection for line to anti-aircraft-artillery information service (AAAIS) receiver.
LINE' binding poets ---	Connection for field telephone line to AM-1780 /VRC. Provides communication on intercom system only.

Note. The INSTALLATION SWITCH is not an operator's control. It is to be operated only by higher maintenance personnel.

3-4. Antenna AS-1729/VRC, Control and Connectors (fig. 3-3)

Control or connector	Function
S1 switch -----	Ten-position rotary switch. Selects proper loading for antenna.
J1 connector -----	Connection for Cable Assembly, Radio Frequency CG-177/U from ANT connector on RT-505/PRC-25.
J2 connector -----	Connection for Cable Assembly Special Purpose CX-4722/U from ANTENNA CONTROL connector on amplifier-power supply.

3-5. Control, Intercommunication Set C-2297/VRC, Controls, Indicator, and Connectors (fig. 3-4)

Typical audio accessories are shown in figure 2-3 The C-2297/VRC is located near the driver in vehicles and track vehicles.

Control, Indicator, or connector	Function												
MONITOR switch -----	Selects either intercom or radio signals heard and permits control of receiver-transmitter by operator of audio accessory connected to J902 and J903. <table border="0"> <tr> <td style="text-align: right;">Sw pos</td> <td style="text-align: center;">Action</td> </tr> <tr> <td>ALL -----</td> <td>Send and receive on the intercom (audio accessory connected to J903 (yellow mark)); send and receive on the receiver-transmitter (audio accessory connected to J902). When the SIG switch is on EXT, operator at C-2296/VRC can communicate on the radio.</td> </tr> <tr> <td>A -----</td> <td>Send and receive on receiver-transmitter (audio accessory connected to J902). When the SIG switch is on EXT, operator at C-2296/VRC can communicate on the radio.</td> </tr> <tr> <td>INT ONLY ---</td> <td>Hears and talks on intercom facilities only (audio accessory connected to J903 (yellow mark)).</td> </tr> <tr> <td>B -----</td> <td>Not used.</td> </tr> <tr> <td>C -----</td> <td>Not used.</td> </tr> </table>	Sw pos	Action	ALL -----	Send and receive on the intercom (audio accessory connected to J903 (yellow mark)); send and receive on the receiver-transmitter (audio accessory connected to J902). When the SIG switch is on EXT, operator at C-2296/VRC can communicate on the radio.	A -----	Send and receive on receiver-transmitter (audio accessory connected to J902). When the SIG switch is on EXT, operator at C-2296/VRC can communicate on the radio.	INT ONLY ---	Hears and talks on intercom facilities only (audio accessory connected to J903 (yellow mark)).	B -----	Not used.	C -----	Not used.
Sw pos	Action												
ALL -----	Send and receive on the intercom (audio accessory connected to J903 (yellow mark)); send and receive on the receiver-transmitter (audio accessory connected to J902). When the SIG switch is on EXT, operator at C-2296/VRC can communicate on the radio.												
A -----	Send and receive on receiver-transmitter (audio accessory connected to J902). When the SIG switch is on EXT, operator at C-2296/VRC can communicate on the radio.												
INT ONLY ---	Hears and talks on intercom facilities only (audio accessory connected to J903 (yellow mark)).												
B -----	Not used.												
C -----	Not used.												
VOLUME control -----	Adjusts audio output to audio accessory at connectors J902 and J903.												
EXT indicator -----	When lighted, lamp indicates C-2296/VRC is in use or operator at C-2296/VRC wishes to communicate with personnel inside the vehicle.												
SIG switch -----	Controls connections to the C-2296/VRC. <table border="0"> <tr> <td style="text-align: right;">Sw pos</td> <td style="text-align: center;">Action</td> </tr> <tr> <td>OFF -----</td> <td>Turns off control connections to C-2296/VRC.</td> </tr> <tr> <td>EXT -----</td> <td>Connects control connections to C-2296/VRC: EXT indicator lamp lights,</td> </tr> <tr> <td>SIG (spring-loaded)</td> <td>Signals operator at C-2296/VRC; EXT indicator lights,</td> </tr> </table>	Sw pos	Action	OFF -----	Turns off control connections to C-2296/VRC.	EXT -----	Connects control connections to C-2296/VRC: EXT indicator lamp lights,	SIG (spring-loaded)	Signals operator at C-2296/VRC; EXT indicator lights,				
Sw pos	Action												
OFF -----	Turns off control connections to C-2296/VRC.												
EXT -----	Connects control connections to C-2296/VRC: EXT indicator lamp lights,												
SIG (spring-loaded)	Signals operator at C-2296/VRC; EXT indicator lights,												
J903 (connector yellow mark) -----	Connection for audio accessory; permits control of intercom facilities.												
J902 connector -----	Connection for audio accessory; permits control of radio facilities.												

3-6. Control, Intercommunication Set C-2298/VRC, Controls and Connectors
(fig. 3-5)

Typical audio accessories are shown in figure 2-3

Control or connector	Function												
MONITOR switch -----	Selects either intercom or radio signal heard and permits control of receiver-transmitter by operator of audio accessory connected to J802 and J803. <table border="0"> <tr> <td style="text-align: right;">Sw pos</td> <td style="text-align: center;">Action</td> </tr> <tr> <td>ALL -----</td> <td>Send and receive on intercom (audio accessory connected to J803) ; send and receive on the receiver-transmitter (audio accessory connected to J802).</td> </tr> <tr> <td>A -----</td> <td>Send and receive on receiver-transmitter (audio accessory connected to J802).</td> </tr> <tr> <td>INT ONLY ---</td> <td>Hear and talk on intercom facilities only (audio accessory connected to J803).</td> </tr> <tr> <td>B -----</td> <td>Not used.</td> </tr> <tr> <td>C -----</td> <td>Not used.</td> </tr> </table>	Sw pos	Action	ALL -----	Send and receive on intercom (audio accessory connected to J803) ; send and receive on the receiver-transmitter (audio accessory connected to J802).	A -----	Send and receive on receiver-transmitter (audio accessory connected to J802).	INT ONLY ---	Hear and talk on intercom facilities only (audio accessory connected to J803).	B -----	Not used.	C -----	Not used.
Sw pos	Action												
ALL -----	Send and receive on intercom (audio accessory connected to J803) ; send and receive on the receiver-transmitter (audio accessory connected to J802).												
A -----	Send and receive on receiver-transmitter (audio accessory connected to J802).												
INT ONLY ---	Hear and talk on intercom facilities only (audio accessory connected to J803).												
B -----	Not used.												
C -----	Not used.												
VOLUME control -----	Adjusts audio output to audio accessory at connectors J802 and J803.												
J803 connector (yellow mark) --	Connection for audio accessory; permits use of intercom facilities.												
J802 connector -----	Connection for audio accessory; permits use of radio facilities.												

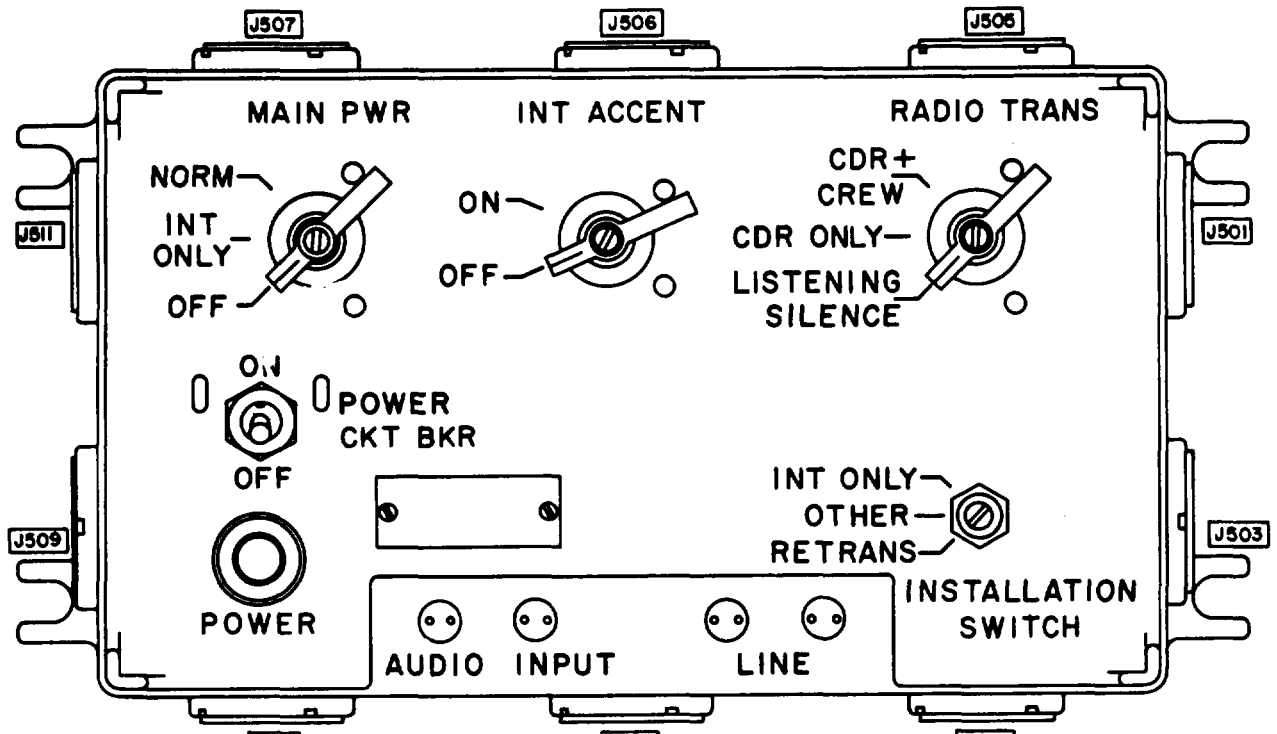

TM5820-498-10-10

Figure 3-2. Amplifier, Audio-Frequency AM-1780/VRC, controls, indicator, and connector.

3-7. Control, Intercommunication Set C-2296/VRC, Controls and Connectors (fig. 3-6) The C-2296/VRC is mounted on the outside of track vehicles.

Control or connector	Function
VOLUME control	Adjusts volume to the earphone of the H-207/VRC.
RAD TRANS-INT switch	Selects radio transmission (RAD TRANS) or intercom (INT) operation; RAD TRANS position is spring-loaded. See ALL and A switch positions on C-2297/VRC (para 3-5).
LINE binding posts	Connection for field telephone lines to C-2296/VRC; communication is on intercom only.
J62 connector	Connection for indicator lamp cable.
Handset H-207/VRC	Permits operator to communicate on intercom or radio facilities of radio set. Pressing the push-to-talk switch lights the EXT indicator lamp on the C-2297/VRC.

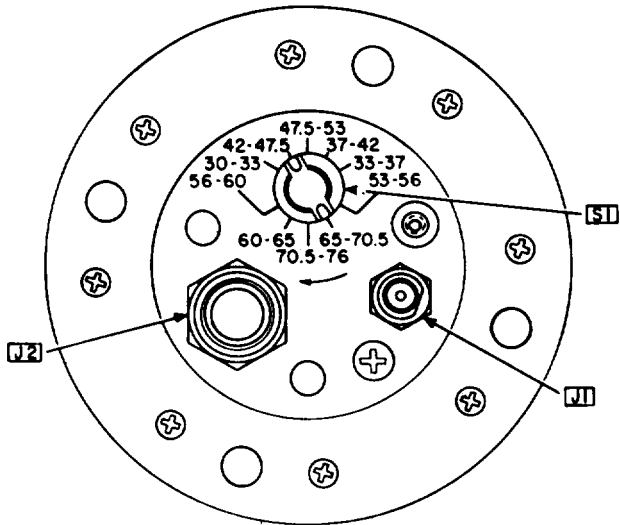

Figure 3-3. Antenna AS-1729/VRC, control and connectors.

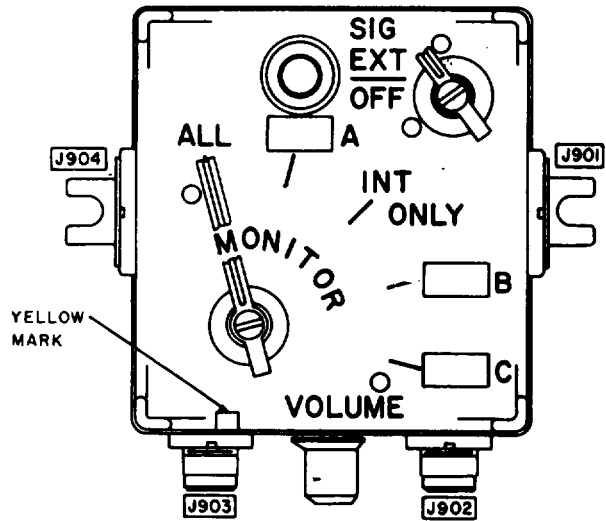

Figure 3-4. Control, Intercommunication Set C-2297/VRC, controls, indicator, and connectors.

Section II. OPERATION UNDER USUAL CONDITIONS

Warning: Before operating this equipment, make certain that all requirements of TB SIG 291 are met. Injury or DEATH could result from improper or careless operation.

Cautions:

Read and follow the operating cautions enumerated on the inside front cover of this manual. Failure to observe some of these cautions can result in damage to the equipment or in communication failure.

3-8. Siting

a. Communication range can also be increased by the use of antennas other than those issued with the radio sets. Refer to paragraphs 6-15 and 6-16 for information on other antennas. Communication range can also be increased on a vehicular-mounted radio set by communicating with the distant radio station with the front end of the vehicle *pointing* in the direction of

the distant station. The mass of the vehicle between the whip antenna and the distant station facilitates communication. FM 24-18 provides useful information for siting and radio operator procedures.

b. Remote control up to 2 miles by the use of Radio Set Control Group AN/GRA-39 or AN/GRA-39A is described in paragraph 6-12.

c. When the AN/PRC-25 or AN/VRC-53 is

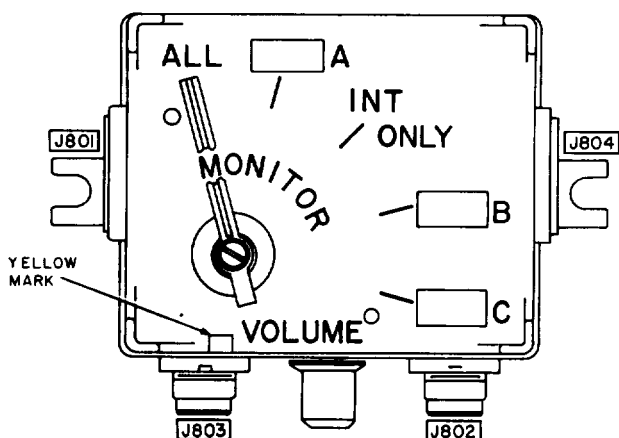

Figure 3-5. Control, Intercommunication Set C-2298/VRC, controls and connectors

used as a retransmission facility in a radio relay link using Retransmission Cable Kit MK-456/GRC, the radios must be separated by the 50-foot length of the cable in the kit. Para-

graph 6-13 contains information on the procedures for the use of the MK-456/GRC.

d. Because of the low power and high frequency (HF) used, the location of the equipment affects its operating range. Normally, a line-of-sight range can be expected. That is, if the other station can be seen, satisfactory operation is probable. An intervening hill or tall building may hamper or prevent contact with the other station. Valleys, depressions, densely wooded areas, and low places are poor sites. Location on a hilltop or tower will increase operating distance. If possible, avoid locations near sources of electrical interference, such as power or telephone lines, radar sets, and field hospitals.

3-9. Recognition and Identification of Jamming

Under real or simulated tactical conditions, it is possible for the receiver to be jammed by the enemy. Jamming is easily done by transmitting

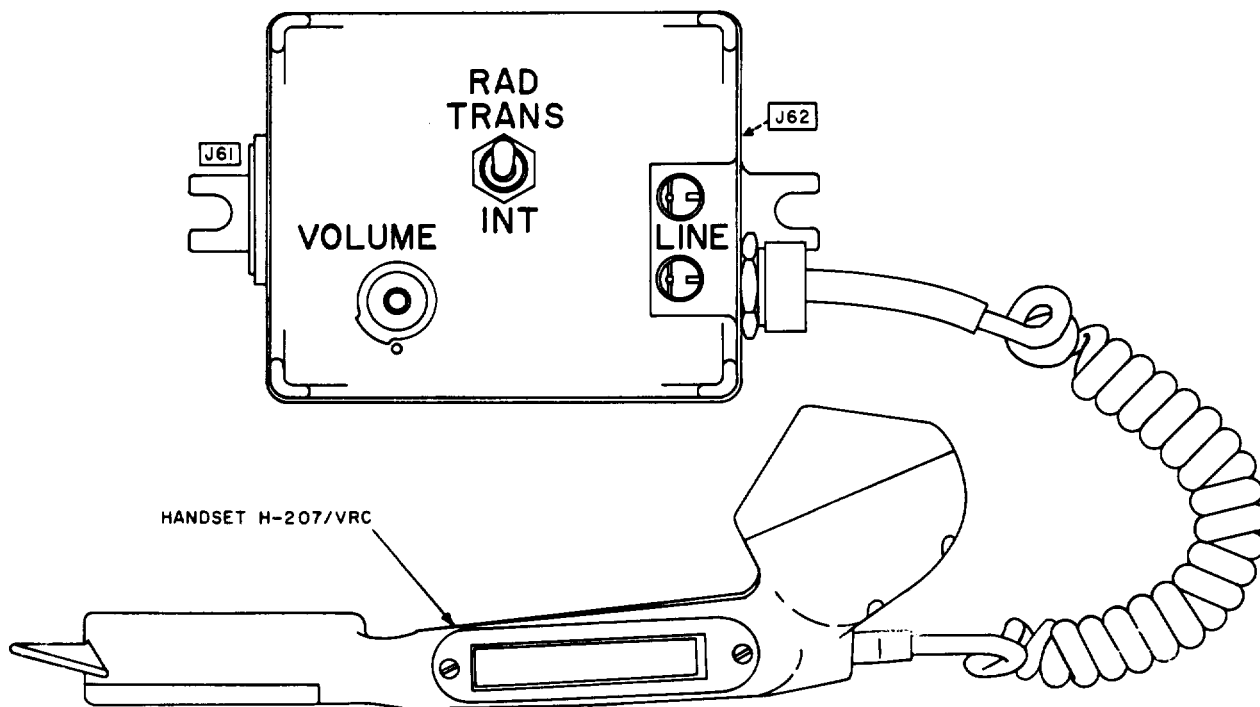

Figure 3-6. Control, Intercommunication Set C-2296/VRC, controls and connectors.

a strong signal on the same frequency, making it difficult or impossible to hear the desired signal. Unusual noises or strong interference heard on the receiver may be enemy jamming, signals from a friendly station, noise from a local source, or a defective receiver. To determine whether the interference is originating in the receiver, disconnect the antenna and short the center conductor to the chassis. If the interference continues, the receiver is defective.

3-10. Antijamming

When it is first noticed that a channel is being jammed, notify your superior officer immediately and continue to operate the equipment. To provide maximum intelligibility of jammed signals, follow the operating procedure below:

a. The effects of enemy jamming may be reduced by locating the equipment so that nearby obstructions act as a screen in the direction of probable sites of enemy jamming transmitters. This screen action may also reduce the transmitted signal strength toward the enemy, thereby making it more difficult for the enemy to intercept the signals. If possible, try several different locations within the designated area and stay at the location where jamming is minimum.

b. Vary the VOLUME control. The level of the desired signal may be raised enough to be distinguished from the jamming signal.

c. If the above procedures do not provide sufficient signal separation for operation, change to the alternate frequency and call sign.

3-11. Presetting Channel Frequencies

(fig. 3-1 and 3-7)

On the mc and kc controls (fig. 3-1), there are preset levers that can be set to catch the stops on each control (fig. 3-7). Thus, when two channels are preset, they can be selected without looking at the channel dial (fig. 3-1). Use the procedures in *a* below to set the kc control; use the procedures in *b* below control.

Note

When presetting the controls, the two frequencies to be set must be considered the *lower* and the *higher* frequency; and the sections of each tuning control as the *upper* (next to the front panel) and the lower section (fig. 3-7).

a. Presetting Kc Tuning Control. The kc control is set before the mc control (*b* below). Determine the lower and the higher kc frequencies. (*For example: 35 in 59.35 mc, 70 in 39.70 mc, etc.*)

(1) Set the preset lever away from the kc control (A and B, fig. 3-7).

(2) Set the kc control so that the lower frequency appears in the channel dial.

(3) Position the preset lever forward against the control (C, fig. 3-7) and loosen the wingnut on the control.

(4) Pull up on the lower section of the control and turn it counterclockwise until the stop on the lower section strikes the preset lever. Tighten the wingnut.

(5) Position the preset lever away from the control.

(6) Turn the control until the higher frequency appears in the channel dial (both sections move).

(7) Loosen the wingnut and position the preset lever forward against the control.

(8) Without disturbing the setting of the lower section, pull on the upper section and turn it clockwise until its stop strikes the preset lever.

(9) Keeping the upper section against the preset lever, tighten the wingnut.

(10) Check the settings for the lower and higher kc frequency settings by turning the control counterclockwise to the stop for the lower kc frequency, and clockwise to the stop for the higher kc frequency.

(11) Set the mc control (*b* below).

b. Presetting Mc Tuning Control. The mc control is set after the kc control (*a* above).

Determine the assigned lower and higher mc frequencies. (For example: 59 in 59.35 mc, 39 in 39.70 mc, etc.)

(1) *Presetting mc frequencies in same band.* The procedure for presetting the lower and upper sections of the mc control for mc frequencies *that are in the same band* are the same as those given for the kc control in *a* above. That is, the lower mc frequency in the band is set with the lower section of the control; and the higher mc frequency in the same band is set with the upper section.

(2) *Presetting mc frequencies in different bands.* Note that there are 23 positions of the control in each band: from 30 through 52 in band A; from 53 through 75 in band B.

(a) When presetting the mc control for frequencies that are in *different* bands, always set the *lower* section to that mc frequency that is *lower in its band* than the mc frequency in the other band. For example: 54 is lower (second position) in band B than 33 mc (fourth position) in band A; thus, 54 mc would be set on the *lower* section and 33 mc would be set on the *upper* section.

(b) To preset the mc control sections, set the BAND switch to A or B position, as appropriate, then use the same procedures in *a* above on the mc control and with the information given in *(a)* above.

3-12. Conditions for Squelch and Nonsquelch Operation

The following explanations and squelch operating conditions are applicable to all radio operations given in paragraphs 3-13 and 3-14.

a. Function Switch.

(1) When the function switch of the receiver-transmitter is set to ON, rushing noise is heard in the audio accessory. The rushing noise stops when the receiver-transmitter, or another transmitter operating on the same frequency, is turned on.

(2) When the function switch is set to SQUELCH, no sound is heard in the audio accessory until the receiver-transmitter, or another transmitter operating on the same frequency, is turned on, *provided the other transmitter is provided with a 150-cycle.*

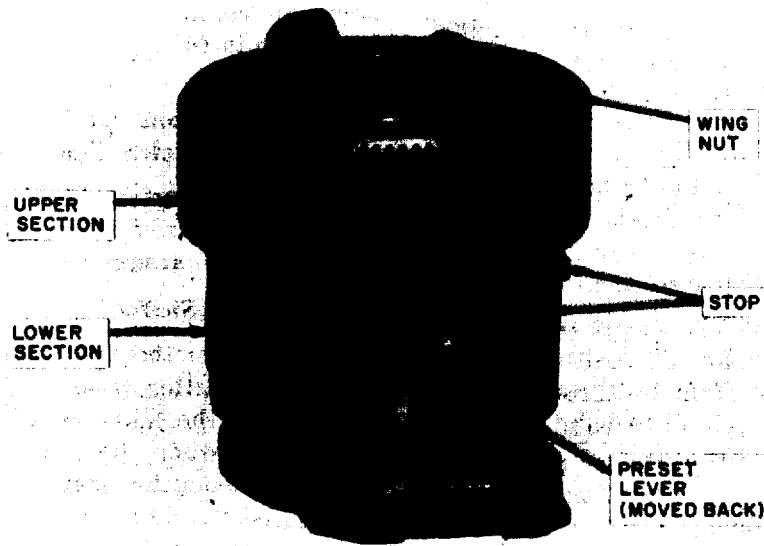

A. TUNING CONTROL; LOWER AND UPPER SECTIONS LIFTED.

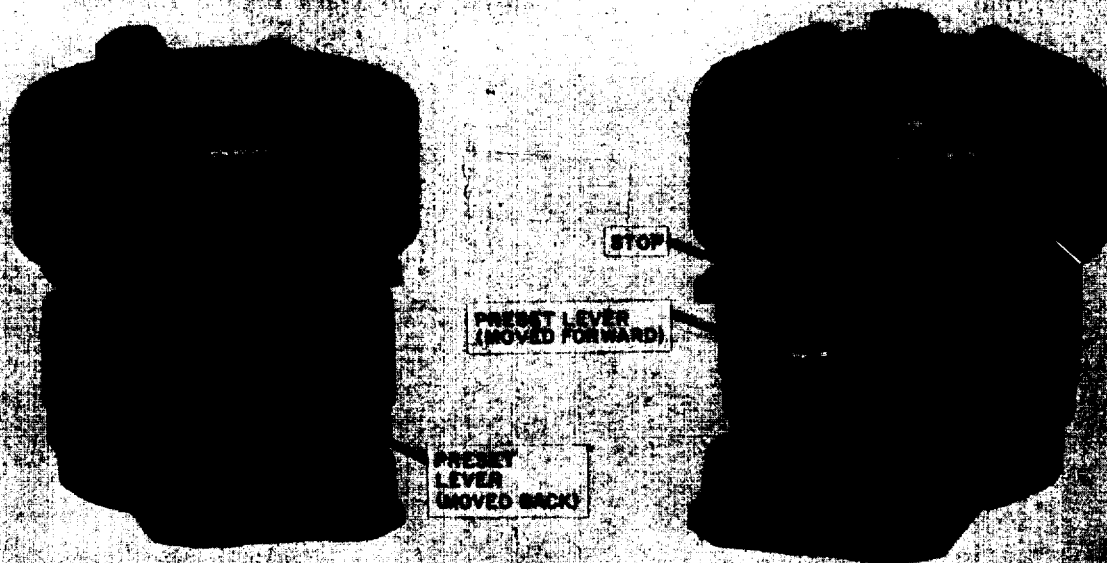

B. TUNING CONTROL; UPPER SECTION LIFTED.

C. TUNING CONTROL; STOP AGAINST PRESET LEVER.

TM 11-5820-498-12

Figure 3-7. Presetting mc and kc tuning controls.

per second (cps) squelch signal in its transmission (such as radio sets listed in *b* below). When the receiver-transmitter is turned on for transmission, a 150-cps squelch signal is transmitted and the low-level 150-cps buzz is heard as sidetone in the audio accessory.

b. Squelch Reception Conditions. When the function switch is set to SQUELCH, reception from a distant transmitter is possible under the following conditions:

(1) When the other station is using Radio Set AN/PRC-25, AN/PRC-77, AN/VRC-53, AN/VRC-64, AN/GRC-125, or AN/GRC-160.

(2) When the other station is using Radio Sets AN/VRC-12 and AN/VRC-43 through AN/VRC-49, *provided the SQUELCH switch of its receiver-transmitter is set to NEW ON, NEW OFF, or OLD OFF.*

(3) When the other station is using Radio Set AN/ARC-54, -114, or -131.

c. Squelch Transmission Conditions. In order for a *distant* radio listed in *b* above to use its squelch feature, the function switch of the receiver-transmitter can be set to ON or SQUELCH position.

d. Determining Use of Squelch. To decide whether squelch operation is possible, use the following procedures:

(1) Arrange for the distant station *operating without its squelch* to send a short transmission.

(2) Set the function switch to ON; the rushing noise should be heard until the other station transmits.

(3) Arrange with the other station to turn on its squelch switch to *NEW ON* position and send a short test transmission.

(4) On the receiver-transmitter, set the function switch to SQUELCH; the rushing noise should stop and distant station should be heard when it transmits.

(5) If the other station cannot be heard now, reset the function switch to ON and advise the other station of the situation.

NOTE

The failure of either station to receive the

other on squelch operation may indicate that the distance between the two stations is too great or that the squelch circuit of either radio station is defective.

(6) If either radio station is moving about, leave the function switch to ON at both stations until it has been determined (by using procedures given in (1) through (5) above) that reception can be accomplished with the function switch in the SQUELCH position.

3-13. Operating Procedure for Radio Set AN/PRC-25 and AN/PRC-77 (fig. 3-1)

Connect the handset to one of the AUDIO connectors (fig. 1-6).

a. Set the function switch at ON.

b. Set the BAND switch at 30-52 or 53-75, depending on the frequency being used.

NOTE

If a preset channel is to be used, select the preset channel as given in paragraph 3-11 in place of the procedure given in *c* below. If a preset channel is not to be used, make sure that the PRESET levers are away from the mc tuning and kc tuning controls.

c. Turn the mc tuning and kc tuning controls so that the desired channel shows in the channel dial.

CAUTION

Do not force the VOLUME control past its stops.

d. Set the VOLUME control at 4; readjust for a desired sound level in the handset.

e. Set the function switch at ON. Refer to paragraph 3-12*a, b,* and *c* for squelch operation conditions and perform the procedures in 3-12*d* to use the squelch feature.

f. Transmit as follows:

(1) Press the handset push-to-talk switch.

(2) Speak into the handset.

NOTE

Without the power receptacle cover in place, the receiver/transmitter will not operate in a man-pack configuration.

g. To receive, release the handset push-to-talk switch.

h. To shut down the equipment, proceed as follows :

(1) Set the function switch at OFF.

(2) If the AT-271A/PRC (fig. 1-13) was used, disassemble it as follows:

(a) Unscrew the AT-271 A/PRC from the AB-591/PRC-25.

(b) Beginning with the top section, pull out each section from the next section and fold it along the side of the next lower section.

(3) Unscrew the AB-591/PRC-25 from the ANT mount connector.

(4) If Antenna AT-892/PRC-25 was used, unscrew it from the ANT mount.

(5) Store the handset, both antennas, and the AB-591/PRC-25 in the CW-503/PRC-25.

(6) Close the flap on the CW-503/PRC-25.

3-14. Operating Procedure for Amplifier-Power Supply Group OA-3633/GRC and Receiver-Transmitter, Radio RT-505/PRC-25 (fig. 3-1)

a. Connect the handset or microphone to either of the two receiver-transmitter AUDIO connectors.

b. Turn the receiver-transmitter function switch to ON.

c. Turn the amplifier-power supply PWR switch to ON. This operation permits power to be applied to the AM-2060/GRC and the receiver-transmitter.

WARNING

If operating under blackout conditions, do not hold the function switch at LITE.

d. Adjust the receiver-transmitter VOLUME control until background noise is heard,

e. If squelch operation is to be used, refer to paragraph 3-12a, b, and c for squelch operation conditions and perform the procedures given in 12d to use the squelch feature.

f. If the amplifier-power supply loudspeaker is to be used, proceed as follows:

(1) Set the SPKR switch to ON.

(2) Adjust the receiver-transmitter VOLUME control to a desired listening level.

g. Tune the receiver-transmitter as follows:

(1) Turn the BAND switch to 30-52 or 53-75, depending on the frequency band desired.

(2) Turn the mc tuning and kc tuning controls until the operating frequency appears on the channel dial.

h. To select a preset frequency, proceed as follows :

(1) Set the PRESET levers forward (toward the mc tuning and kc tuning controls),

(2) Set the BAND switch at 30-50 or 53-75, depending on the frequency used.

(3) Turn the mc tuning and kc tuning controls until the stops strike against the PRESET levers.

(4) Check the frequency number that appears in the dial.

(5) If the incorrect frequency appears in the dial, turn the tuning control against the stop in the opposite direction.

(6) If the incorrect frequency still appears, perform the presetting procedure given in paragraph 3-7.

(7) To select the other preset frequency, turn the mc tuning and kc tuning controls against the other stops. If the preset frequency is in the other band, set the BAND switch at the other position.

i. Turn the AM-2060/GRC ANT. FREQ. CONTROL to the position that includes the selected operating frequency.

CAUTION

If the H-138(*)/U is used (*j* below), do not speak into both microphone elements. The H-138(*)/U has two microphone elements for noise cancellation; speaking into both elements at the same time will cancel out your voice.

j. To transmit, press the handset push-to-talk switch and speak into one microphone element; to receive, release the switch.

k. To turn the radio set off-

- (1) Set the AM-2060/GRC PWR switch to OFF.
- (2) Turn the receiver-transmitter function switch to OFF.

3-15. Operating Procedure for Amplifier, Audio Frequency AM-1780/VRC (fig. 3-2)

The following procedures must be performed before other crewmember control boxes can be used (para 3-16 through 3-19).

a. Turn on power to the radio set system as follows :

- (1) Set the amplifier-power supply PWR switch to ON. Set the receiver-transmitter function switch to ON. (If the receiver-transmitter operates now, the link in the MT-1029/VRC should be changed to remote control (para 2-5a (2).))
- (2) Turn the receiver-transmitter VOLUME control fully clockwise; each crewmember will use the VOLUME control on his control box to adjust the sound to comfortable listening level.
- (3) Turn the MAIN PWR switch to NORM. (When the INSTALLATION SWITCH is in the INT ONLY position, turn the MAIN PWR switch to INT ONLY; in this condition, radio transmission cannot be performed.)
- (4) Set the POWER CKT BKR switch to ON; the POWER indicator will light. This action permits power to be applied to the microphones of the audio accessories for radio and intercom transmission.
- (5) If the POWER CKT BKR switch trips to OFF, an overload is present. To reset, set the POWER CKT BKR switch to ON.

Caution: If the circuit breaker trips again after being reset, do not reset it again. Troubleshooting is required.

b. Turn the INT ACCENT switch to ON for the intercom signals to be louder than the radio signals. Turn the INT ACCENT switch to OFF for the intercom and radio signals to be of the same volume.

c. Select crewmembers to operate the receiver-transmitter as follows:

- (1) If all crewmembers are to operate the receiver-transmitter, set the RADIO TRANS switch to CDR + CREW.
- (2) If only the commander is to operate the receiver-transmitter, turn the RADIO TRANS switch to CDR ONLY.
- (3) To prevent the commander and crewmembers from operating the receiver-transmitter, turn the RADIO TRANS switch to LISTENING SILENCE.

3-16. Operating Procedure for Control, Intercommunication Set C-2296/VRC (fig. 3-6)

The C-2296/VRC usually is mounted outside the vehicle or weapon. Handset H-207/VRC is part of the C-2296/VRC.

a. To signal personnel inside the vehicle or weapon, proceed as follows:

- (1) Controls in the AM-1780/VRC must be set as outlined in paragraph 3-15.
- (2) Remove the handset from its stored position.
- (3) Press the push-to-talk switch; the indicator connected to J62 on the C-2296/VRC will light, and one on the C-2297/VRC inside the vehicle will also light.

Note. When the handset switch is pressed, the lamp will stay lighted until personnel stationed inside at the C-2297/VRC (para 3-17) answer by setting the EXT switch on the C-2297/VRC to EXT. It is not necessary to keep the switch pressed.

b. To communicate with personnel inside the vehicle after the signal (*a* above) is answered—

- (1) Press the handset push-to-talk switch to talk; release the switch to listen.
- (2) Adjust the VOLUME control for the desired volume while listening.

c. To communicate on the receiver-transmitter, proceed as follows:

- (1) Request the crewman at the C-2297/VRC inside the vehicle to set the MONITOR switch to ALL or A position.

- (2) While holding the RAD TRANS-INT switch in the RAD TRANS position, press the handset push-to-talk switch to talk to the distant radio station; release the switch to listen.
- (3) At the end of the radio communication, release the RAD TRANS-INT switch.

d. To communicate from a field telephone either with the operator of the C-2296/VRC or to the crewmembers inside the vehicle or weapon, refer to paragraph 3-19.

Note. When the indicator lamp connected to J62 on the C-2296/VRC lights, personnel inside are trying to establish communication with personnel outside the vehicle or weapon (para 3-17f).

3-17. Operating Procedure for Control, Intercommunication Set C-2297/VRC (fig. 3-4)

The C-2297/VRC usually is located at the driver's position.

- a. Set the AM-1780/VRC controls as outlined in paragraph 3-15.
- b. Adjust the VOLUME control for the desired volume in the audio accessory.
- c. To communicate on the receiver-transmitter, proceed as follows:

- (1) Turn the MONITOR switch to ALL or A.
- (2) Press the push-to-talk switch of the audio accessory to transmit, and release the switch to receive.

d. To talk to the commander, other members of the crew, or an operator at the C-2296/VRC, perform the procedures given in (1), (2), or (3) below.

- (1) When using an audio accessory, such as CVC Helmet, H-161/U, or equivalent, set the switch on the audio accessory to interphone position and talk to the other crewmembers. (The MONITOR switch on the C-2297/

VRC can be in ALL, A, or INT ONLY positions for this situation.)

- (2) When using a microphone connected to J903 (yellow mark), press the push-to-talk switch and speak into the microphone.
- (3) When using a microphone connected to J902, proceed as follows:
 - (a) Turn the MONITOR switch to INT ONLY.
 - (b) Press the push-to-talk switch and speak into the microphone.

e. To answer personnel outside the vehicle or weapon, proceed as follows:

- (1) After the EXT indicator lights, turn the SIG switch to EXT.
- (2) When using an audio accessory, such as CVC Helmet, H-161/U, or equivalent, set the switch on the audio accessory to interphone position and talk to the other crewmembers.
- (3) When using a microphone connected to J903 (yellow mark), press the push-to-talk switch and speak into the microphone,

Note. The EXT indicator remains lighted to indicate that the SIG switch is in the EXT position.

f. To signal personnel outside the vehicle or weapon, proceed as follows:

- (1) Hold the SIG switch in the SIG position. An indicator lamp connected to the C-2296/VRC will light.
- (2) After communication with personnel outside the vehicle or weapon is finished, release the SIG switch back to the EXT position.

3-18. Operating Procedure for Control, Intercommunication Set C-2298/VRC (fig. 3-5)

a. Set the AM-1780/VRC controls as outlined in paragraph 3-15.

b. Adjust the VOLUME control for the desired volume in the audio accessory.

c. To communicate on the receiver-transmitter:

- (1) Turn the MONITOR switch to ALL or A.

(2) When using an audio accessory, such as CVC Helmet, H-161/U, or equivalent, hold the switch on the audio accessory to the radio position to transmit; release the switch to receive.

(3) If a microphone connected to J802 is being used, press the push-to-talk switch.

c. To talk to the other members of the crew, perform the procedure given in (1), (2), or (3) below.

(1) When using an audio accessory, operate the switch on the audio accessory to the interphone position. Communication can proceed without any other operation,

(2) If a microphone connected to J803 (yellow mark) is being used, press the push-to-talk switch and speak into the microphone.

(3) If a microphone connected to J802 is being used, turn the MONITOR switch to INT ONLY. Press the push-to-talk switch and speak into the microphone.

e. To listen to the radio without transmitting, set the MONITOR switch on the C-2298/VRC to ALL or A. Leave the switch on the audio accessory to midposition.

f. To listen on the intercom without transmitting, leave the switch on the audio accessory to midposition. The MONITOR switch can be in ALL or INTERCOM.

3-19. Intercom Communication with Lines Connected to G2296/VRC and AM-1780/VRC

a. Connections. To establish communication with a field telephone user, connect field wires from the telephone to the line binding posts of the C-2296/VRC or AM-1780/VRC (fig. 2-3); or to interconnect the intercom cir-

cuits of two or more vehicles, connect field wires from the LINE binding posts of the C-2296/VRC or AM-1780/VRC of one vehicle with the LINE binding posts of the C-2296/VRC or AM-1780/VRC of another vehicle (or vehicles). The radios cannot be controlled under this arrangement; it puts the telephone or two (or more) vehicles on one intercom system.

b. Operation.

CAUTION

The ringing signal from a field telephone can damage the circuits in the AM-1780/VRC. Thus, the telephone user must be advised that he cannot use his telephone ringer to attract the attention of vehicle crewmembers. To attract attention, he should whistle or talk into the telephone.

(1) The AM-1780/VRC controls are set as outlined in paragraph 3-15.

(2) When the lines are connected to the C-2296/VRC, the C-2297/VRC SIG switch must be set to EXT.

(3) Set the MONITOR switch of the vehicle C-2297/VRC or C-2298/VRC to ALL. Only the crew commander's C-2298/VRC MONITOR switch can be set to the C position to communicate on this circuit.

(4) To talk to the other party, set the audio accessory switch to the intercom position and release the switch to hear the reply. Communication must be conducted on a push-to-talk and release-to-receive basis.

CAUTION

If any other crewmember in the vehicle is keyed on the intercom, the reply cannot be heard.

CHAPTER 4

OPERATOR'S MAINTENANCE INSTRUCTIONS

4-1. Scope of Operator's Maintenance

No special tools or test equipment are required for operator's maintenance. Operator's maintenance of the radio sets include the following:

- a. Preventive maintenance (para 4-2 and 4-3).
- b. Visual inspection (para 4-4) and troubleshooting (para 4-5).

4-2. Preventive Maintenance, General

Preventive maintenance is the systematic care, servicing, and inspection of equipment to prevent occurrence of trouble, to reduce downtime, and to assure that the equipment is serviceable. Preventive maintenance

checks and services (PMCS) defines procedures to be performed at specific intervals and under certain conditions (table 4-1).

a. Before you operate, perform your before operation (B) PMCS.

6. While you operate, perform your during operation (D) PMCS. The recording and reporting of your during operation (D) PMCS is done while performing the after operation (A) PMCS.

c. After you operate, perform your after operation (A) PMCS.

d. If the equipment was not used during a week, perform the (B), (D), and (A) PMCS together with the weekly (W) PMCS.

TABLE 4-1.

OPERATOR'S PREVENTIVE MAINTENANCE CHECKS AND SERVICES

NOTE: THE CHECKS IN THE "INTERVAL" COLUMN ARE TO BE PERFORMED IN THE ORDER LISTED.

ITEM NO.	Interval					ITEM TO BE INSPECTED	PROCEDURES CHECK AND HAVE REPAIRED OR ADJUSTED AS NECESSARY	EQUIPMENT IS NOT READY/AVAILABLE IF:
	B-BEFORE OPERATION	D-DURING OPERATION	A-AFTER OPERATION	W-WEEKLY	M-MONTHLY			
1.	*					Antenna tip cap (fig. 1-10)	The antenna tip cap is secured to the top antenna element, AT-1095/VRC. Check elements for splits and cleanliness.	
2.		*				Antenna tie down assembly: (fig. 2-7)	If used, the antenna is pulled down to an angle that will not endanger personnel and is tied down in the inverted V method.	
3.				*		Antenna matching unit	a. The ground strap is connected between the matching unit and the vehicle. b. The safety wire is in place c. The O-ring is in place.	
4.			*		*	Amplifier power supply	d. Remove/replace water drain screw. Set amplifier power supply ANT FREQ CONTROL (fig. 3-1) to each position. At each position, the relay rotor in the antenna matching unit should be heard operating. On the MX-6707/VRC (fig. 3-3), switch S1 should point to the same frequency band on the ANT FREQ CONTROL.	a. Relay rotor in antenna matching unit MX-6707/VRC can't be heard operating. b. If S1 and ANT FREQ CONTROL do not point to same frequency, and cannot be manually set, the mismatch can cause damage to the radio.

WARNING
DO NOT USE HIGH PRESSURE WATER WHEN CLEANING THE ANTENNA SYSTEM.

TABLE 4-1.

OPERATOR'S PREVENTIVE MAINTENANCE CHECKS AND SERVICES

NOTE: THE CHECKS IN THE "INTERVAL" COLUMN ARE TO BE PERFORMED IN THE ORDER LISTED.

ITEM NO.	Interval					ITEM TO BE INSPECTED	PROCEDURES CHECK AND HAVE REPAIRED OR ADJUSTED AS NECESSARY	EQUIPMENT IS NOT READY/AVAILABLE IF:
	B-BEFORE OPERATION	D-DURING OPERATION	A-AFTER OPERATION	W-WEEKLY	M-MONTHLY			
5.				*		Power Cable CX-4720/VRC (fig. 1-11)	a. In wheeled vehicles, the cable is connected to vehicle battery. The cable leads are secured to battery terminals: red-white leads to positive (+) battery terminal; black-green leads to negative (-) terminal. b. In tracked vehicles, the "Bendix" connector assembly is secured to the vehicle power outlet.	a. Cable leads cannot be securely connected.
6.	*					Mounting clamps (figs. 1-7 & 1-8)	The amplifier power supply and MT-1029/VRC mounting clamps hold the equipment securely. MT-1029/VRC & mounting hardware are serviceable.	The equipment cannot be securely clamped in the mount.
7.				*		Audio accessory cable connector (figs. 6-2 & 6-3)	a. The O-ring is in place and is not loose. b. The connector locks securely to the radio and/or crewmember control box connector. c. Clean the connector 5-pin contacts using a pencil eraser.	
8.		*				Radio operation	While operating the radio, check the following: a. Switches and controls can be moved to all their positions.	

TABLE 4-1.

OPERATOR'S PREVENTIVE MAINTENANCE CHECKS AND SERVICES

NOTE: THE CHECKS IN THE "INTERVAL" COLUMN ARE TO BE PERFORMED IN THE ORDER LISTED.

ITEM NO.	Interval					ITEM TO BE INSPECTED	PROCEDURES CHECK AND HAVE REPAIRED OR ADJUSTED AS NECESSARY	EQUIPMENT IS NOT READY/AVAILABLE IF:
	B-BEFORE OPERATION	D-DURING OPERATION	A-AFTER OPERATION	W-WEEKLY	M-MONTHLY			
9.		*				Radio communication	<p>b. The VOLUME control does not bind and there is no interruption of the signal as the control is rotated through its range.</p> <p>c. Squelch operation is satisfactory. (para 3-12) .</p> <p>d. Communication is not intermittent.</p> <p>Insure the distance between the radio being tested and the distant radio is at least 5 miles. Under local conditions (based on experience) of terrain, assigned operating frequencies and with antenna not tied down, the following vehicle applications apply:</p> <p>a. In vehicles not provided with crewmember control boxes (fig. 2-3), radio communication can be conducted.</p> <p>b. In vehicles provided with crewmember control boxes, radio communication can be conducted by all crewmembers.</p>	<p>a. Radio communication cannot be conducted.</p> <p>b. Radio communication cannot be conducted when the audio accessory is connected directly to the receiver/transmitter.</p>

TABLE 4-1.

OPERATOR'S PREVENTIVE MAINTENANCE CHECKS AND SERVICES

NOTE: THE CHECKS IN THE "INTERVAL" COLUMN ARE TO BE PERFORMED IN THE ORDER LISTED.

ITEM NO.	Interval					ITEM TO BE INSPECTED	PROCEDURES CHECK AND HAVE REPAIRED OR ADJUSTED AS NECESSARY	EQUIPMENT IS NOT READY/AVAILABLE IF:
	B	D	A	W	M			
10.	*		*			Battery and Battery box CY-2562/PRC-25	<ul style="list-style-type: none"> c. When man-packed communication can be established with distant station. d. Check with your C&E maintenance once every ninety days to insure the receiver/transmitter has been tested for sufficient RF power output. a. Remove battery if radio will not be used again that day or longer. b. Check to see that the battery case is not swollen or lacking and the contact receptacle is not damaged. c. Check to see that the battery box pressure relief valve is secure. 	<ul style="list-style-type: none"> c. Radio communication cannot be conducted. Case is leaking or contact receptacle is damaged and a new battery is not available.
11.	*		*			Handset	<ul style="list-style-type: none"> Check to see that: <ul style="list-style-type: none"> a. The handset is not cracked. b. Cord is not cut, wires are not exposed and it coils properly. c. Switch cover is in place and not cut. d. O-ring is in place and not loose in its groove. 	<ul style="list-style-type: none"> a. The case is cracked. b. Wires are cut or exposed. c. O-ring is missing or damaged.

TABLE 4-1.

OPERATOR'S PREVENTIVE MAINTENANCE CHECKS AND SERVICES

NOTE: THE CHECKS IN THE "INTERVAL" COLUMN ARE TO BE PERFORMED IN THE ORDER LISTED.

ITEM NO.	Interval					ITEM TO BE INSPECTED	PROCEDURES CHECK AND HAVE REPAIRED OR ADJUSTED AS NECESSARY	EQUIPMENT IS NOT READY/AVAILABLE IF:
	B-BEFORE OPERATION	D-DURING OPERATION	A-AFTER OPERATION	W-WEEKLY	M-MONTHLY			
12.		*				Crew-member control boxes-intercom operation (not including C-2296/VRC)	e. The connector locks firmly onto the radio. Communication or intercom can be conducted among all crewmembers of any vehicle which requires intercom system.	d. The handset is not able to be secured to the radio. Communication on intercom cannot be conducted by one or more crewmembers especially between the driver and the commander.
13.		*				C-2296/VRC	Radio and intercom Communication can be conducted from the C-2296/VRC.	Communication cannot be conducted when the mission for which the vehicle in use at the time, requires radio and/or intercom communication from the C-2296/VRC.
14.		*				Telephone hook-up from C-2296/VRC or AM-1780/VRC	Telephone communication can be conducted between telephone user and crewmembers (para 3-19)	Communication cannot be conducted when the mission for which the vehicle in use at the time, requires telephone communication with crewmembers.

e. If the equipment fails to operate, try troubleshooting (para 44 and 4-5). If the equipment is damaged, report it using the proper forms; see TM 38-750 for instructions.

f. The *Item No.* column in table 4-1 shall be used as a source of item numbers for the *TM Number* column on DA Form 2404 (Equipment Inspection and Maintenance Worksheet) in recording the results of the PMCS.

g. If the equipment must be kept in constant operation, check and service only those items that can be checked and serviced without disturbing operation. Make the complete checks and services when the equipment can be shut down.

h. Select those items to be inspected and serviced that are authorized for the installation in which the radio is installed. *For example:* items 10, 11, and 12 are only provided in some vehicle installations.

4-3. Cleaning

Inspect the exteriors of the equipment. The exterior surfaces should be clean and free of dust, dirt, grease, and fungus.

a. Remove dust and loose dirt with a clean, soft cloth.

WARNING

Adequate ventilation should be provided while using TRICHLOROTRIFLUOROETHANE. Prolonged breathing of vapor should be avoided. The solvent should not be used near heat or open flame; the products of decomposition are toxic and irritating. Since TRICHLOROTRIFLUOROETHANE dissolves natural oils, prolonged contact with skin should be avoided. When necessary, use gloves which the solvent cannot penetrate. If the solvent is taken internally, consult a physician immediately.

b. Remove grease, fungus, and ground-in-dirt from the cases; use a cloth dampened (not wet) with trichlorotrifluoroethane.

c. Remove dust or dirt from plugs and jacks with a brush.

d. Clean the canvas items with a brush or cloth that has been moistened with trichlorotrifluoroethane.

CAUTION

Do not press on the receiver-transmitter REC-FREQUENCY dial face (glass) when cleaning; the dial face may become damaged.

e. Clean the front panels, dial face, and control knobs; use a soft, clean cloth. If dirt is difficult to remove,

dampen the cloth with water; mild soap may be used for more effective cleaning.

f. Clean the plastic body of the MX-6707/VRC with a cloth dampened with clean water. Never use the following on the plastic surface:

- (1) Cleaning solvent.
- (2) Carbon tetrachloride.
- (3) Trichlorotrifluoroethane.
- (4) Penetrating oils.
- (5) Paint thinner.
- (6) Detergent soap.

g. Clean the contact at the top of the MX-6707/VRC (fig. 1-10) and the curved spring contact at the base of the Antenna Element AS-1730/VRC with the rubber eraser of a pencil. Do not use an ink eraser and never use abrasive, such as emery cloth or scouring powder.

h. Use a pencil eraser to clean the 5-pin connector contacts of the receiver-transmitter AUDIO connectors (fig. 3-1), the crewmember control boxes (fig. 6-1), and the audio accessories (fig. 6-2 and 6-3).

4-4. Visual Inspection

a. When the equipment fails to perform properly, turn off the power and make the following checks:

CAUTION

Do not check any item with the power on.

(1) Improper settings of switches and controls (para 3-1 through 3-7).

(2) Disconnected or improperly connected cables (para 2-5; fig. 2-3).

(3) Broken antenna or antenna cable.

(4) Equipment not properly seated in its mount.

(5) Cable improperly connected to battery. Inspect the dry battery for leakage or swelling.

b. If Antenna AT-912/VRC or AS-1729/VRC is used, check to see that the antenna elements are securely fastened to the spring mount of the antenna matching unit. On the AS-1729/VRC, check to see that the safety wire is affixed.

c. If the checks above do not locate the trouble, proceed to the troubleshooting chart (para 4-5).

4-5. Troubleshooting Charts

Use the following troubleshooting charts in conjunction with equipment failure during operational checks and services (table 4-1) or during normal operation.

a. *Man-Pack Operation.* When substitution

of an item is recommended, either substitute the item in another set, or substitute an item from another set known to be good, in the inoperative set.

Item No.	Indication	Probable trouble	Procedure
1	No power to set.	a. Protective cap not installed on Power connector. b. Defective battery. c. Defective receiver-transmitter	a. Install protective cap on Power connector. b. Substitute a new battery. c. Higher category maintenance required.
2	Unable to transmit and receive.	a. Incorrect frequency setting ---- b. Defective handset ----- c. Defective battery ----- d. Defective squelch circuit -----	a. Set mc and kc tuning dials on assigned frequency. If preset controls of mc and kc tuning dials are being used, check the setting of the controls (para 3-11). b. Substitute handset. c. Substitute a new battery. d. Attempt communication without squelch operation (set the function switch to ON). If still unable to communicate, higher maintenance category troubleshooting required.
3	Unable to transmit; reception is satisfactory.	e. Power receptacle cover a. Defective handset ----- b. Defective battery ----- c. Function switch set to ON and distant station is operating with its squelch in on condition. d. Defective receiver-transmitter -.	e. Insure cover is in place. a. Substitute handset. b. Substitute anew battery. c. Arrange communications without squelch operation at both stations (para 3-12d). f. Higher maintenance category troubleshooting required.
4	Unable to receive from distant terminal; transmission is satisfactory.	a. Defective handset ----- b. Defective battery ----- c. Function switch set to SQUELCH; other station may be transmitting using its non-squelch condition (para 3-12b). d. Defective receiver-transmitter - - -	a. Substitute handset. b. Substitute a new battery. c. Arrange to communicate with Or without squelch at both stations (para 3-12). d. Higher maintenance category troubleshooting required.
5	Reception is weak or getting weaker.	a. Defective battery ----- b. Defective handset ----- c. Defective antenna or other station it too far distant. d. Defective receiver-transmitter- - -	a. Substitute anew battery. b. Substitute the handset. c. Substitute the 10-foot antenna for the short antenna. d. Higher maintenance category troubleshooting required.

b. Vehicle Operation-Not Provided With Intercom System.

Item No.	Indication	Probable trouble	Procedure
1	No power to set.	a. Connections to vehicular battery incorrect or loose. b. Link in MT-1029/VRC incorrectly positioned. c. Defective MT-1029/VRC. d. Power switch on amplifier power supply not set to ON position. e. Defective CX-4655/GRC. f. Defective receiver-transmitter or amplifier power supply.	a. Check for clean, tight, correct battery polarity connections. b. Refer to para 2-5a. c. Higher category maintenance required d. Set switch to ON position. e. Substitute CX-4655/GRC f. Higher category maintenance required

b. Vehicle Operation-Not Provided With Intercom System--Continued.

Item No.	Indication	Probable trouble	Procedure
2	Unable to transmit and receive.	a. Incorrect frequency setting. b. Defective handset c. Defective antenna system d. Defective amplifier-power supply or receiver-transmitter.	a. Set mc and kc tuning dials on assigned frequency. b. Substitute the handset. c. If the whip antenna is tied down, let it stand upright; move the vehicle while attempting to establish communication. Replace the mast sections one at a time. Substitute the CG-1773/U. d. Higher maintenance category troubleshooting required.
3	Unable to transmit; reception is satisfactory.	a. Defective handset ----- b. Function switch set to SQUELCH and distant station is operating with its squelch in off condition. c. Defective amplifier-power supply or receiver-transmitter.	a. Replace the handset. b. Arrange to communicate with or without squelch operation at both stations (para 3-12). c. Higher maintenance category troubleshooting required.
4	Unable to receive; distant station indicates transmission received.	a. Defective handset ----- b. Function switch set to SQUELCH, c. ANT. FREQ. CONTROL on amplifier-power supply not set to position in which operating frequency of receiver-transmitter is set. d. Defective antenna system -----	a. Substitute the handset. b. Set the switch to ON. If reception is still not obtained, higher maintenance category troubleshooting required. c. Set to proper position (para 3-14i). d. Higher maintenance category troubleshooting required.
5	No reception heard on loudspeaker of amplifier-power supply; reception on receiver-transmitter is satisfactory.	a. SPKR switch in OFF position -- b. Defective amplifier-power supply.	a. Set the switch to ON position. b. Higher maintenance category troubleshooting required.

c. Vehicular Operation-Including Intercom System.

Item No.	Indication	Probable trouble	Procedure
1	No power to set.	a. Connections to vehicular battery incorrect or loose. b. Link in MT-1029/VRC incorrectly positioned, c. Defective MT-1029/VRC. d. Power switch on amplifier power supply not set to ON position. e. Defective CX-4655/GRC. f. Defective receiver-transmitter or amplifier power supply.	a. Check for clean, tight, correct battery polarity connections. b. Refer to para 2-5a. c. Higher category maintenance required. d. Set switch to ON position. e. Substitute CX-4655/GRC. f. Higher category maintenance required.
2	Unable to transmit or receive on radio from audio accessory connected to crewmember control box,	a. Incorrect frequency setting.	a. Set mc and kc tuning dials on assigned frequency.

c. Vehicular Operation--Including Intercom System--Continued.

Item No.	Indication	Probable trouble	Procedure
2	<p>Unable to transmit or receive on radio from audio accessory connected to crewmember control box --continued.</p>	<p>On AM-1780/VRC, MAIN PWR, POWER CKT BKR, or INSTALLATION SWITCH incorrectly set.</p> <p>On crewmember control box, MONITOR switch set incorrectly.</p> <p>Defective audio accessory ----- Audio accessory incorrectly connected.</p> <p>Defective receiver-transmitter, amplifier-power supply, or antenna system, or cable.</p>	<p><i>b.</i> Set MAIN PWR switch to NORM, POWER CKT BKR switch to ON, and INSTALLATION SWITCH to OTHER.</p> <p><i>c.</i> Set switch to ALL or A position.</p> <p><i>d.</i> Substitute the audio accessory.</p> <p><i>e.</i> Connect the shorter cable of the audio accessory (fig. 6-2, 6-3; the other cable has a yellow band and is used for transmission on the intercom system) to the right audio connector on the crewmember control box (J902 on the C-2297/VRC; J802 on the C-2298/VRC; fig. 2-3).</p> <p><i>f.</i> Connect the shorter cable of an audio accessory to an AUDIO connector on the receiver-transmitter and attempt to communicate with the distant station. If communication is satisfactory, reconnect the audio accessory to a crewmember control box; if communication is unsatisfactory, leave the audio accessory in the receiver-transmitter. Proceed as follows:</p> <ol style="list-style-type: none"> (1) Substitute the cable between the MT-1029/VRC and connector J501 on the AM-1780/VRC (fig. 2-3). If communication is not restored, refer to <i>b</i> above to check the receiver-transmitter, amplifier-power supply, and antenna system. If communication is still not restored after the corrective measures in <i>b</i> above are attempted, refer the equipment to higher maintenance category to troubleshoot the AM-1780/VRC. (2) Start removing cables one at a time leading from the AM-1780/VRC to the crewmember control boxes (fig. 2-3) ; remove the cable connectors at the AM-1780 /VRC. As each cable is removed, check to see whether radio communication is restored. (3) If communication is not restored after all crewmember control cables have been removed from the AM-1780 /VRC, refer the AM-1780/VRC to higher maintenance category for troubleshooting.

c. Vehicular Operation-Including Intercom System--Continued.

Item No.	Indication	Probable trouble	Procedure
3	Unable to transmit or receive on intercom; radio communication is satisfactory.	<p>a. Defective audio accessory -----</p> <p>b. Audio accessory incorrectly connected.</p> <p>c. Defective intercom equipment _ _</p>	<p>(4) If communication is restored when 1 particular cable is removed at the AM-1780/VRC, reconnect that cable to the AM-1780/VRC and disconnect it from the associated crew-member control box.</p> <p>(5) If communication is restored, refer the crewmember control box to higher maintenance category for troubleshooting. If the communication is not restored substitute the cable.</p> <p>a. Substitute the audio accessory.</p> <p>b. Connect the longer cable of the audio accessory (fig. 6-2, 6-3; the cable has a yellow band and is used for transmission on the intercom system) to the left audio connector on the crewmember control box (J903 on the C-2297 /VRC; J803 on the C-2298/VRC; fig. 2-3). Connect the audio accessory to the crewmember control box; proceed as follows:</p> <p>(1) Start removing cables one at a time leading from the AM-1780/VRC to the <i>other</i> crew-member control boxes (fig. 2-3) ; remove the cable connector at the AM-1780/VRC. As each cable is removed, check to see whether communication is restored,</p> <p>(2) If communication is not restored after removal of the cables from the AM-1780/VRC, refer the AM-1780/VRC to higher maintenance category for troubleshooting.</p> <p>(3) If communication is restored when a particular cable is removed at the AM-1780/VRC, reconnect that cable to the AM-1780/VRC and disconnect it from the associated crew member control box.</p> <p>(4) If communication is restored, refer the crewmember control box to higher maintenance category for troubleshooting. If communication is not restored, substitute the cable,</p> <p>(5) If communication is not restored after the cable is substituted, refer the AM-1780/VRC to higher maintenance category for troubleshooting.</p>

c. Vehicular Operation-Including Intercom System--Continued.

Item No.	Indication	Probable trouble	Procedure
4	Unable to transmit on intercom; reception is satisfactory.	<ul style="list-style-type: none"> a. Switch on AM-1780/VRC incorrectly set. b. Defective audio accessory ----- c. Defective cable ----- 	<ul style="list-style-type: none"> a. Set POWER CKT BKR to ON. POWER indicator lamp should light. If indicator does not light or transmission is not restored, higher maintenance category troubleshooting of AM-1780 /VRC is required. b. Replace the audio accessory. c. Substitute the cable connected between the A M-1780 /VRC and the associated crewmember control box (fig. 2-3). If transmission is not restored, refer A M-1780 /VRC or crewmember control box to higher maintenance category for troubleshooting.
5	Unable to receive on intercom; transmission is satisfactory.	<ul style="list-style-type: none"> a. Defective audio accessory b. Defective cable, AM-1780/VRC, or crewmember control box. 	<ul style="list-style-type: none"> a. Substitute audio accessory. b. Substitute the cable connected between the AM-1780/VRC and associated crewmember control box (fig. 2-3). If reception is not restored, refer the AM-1780/VRC or crewmember control box to higher maintenance category for troubleshooting.

CHAPTER 5

ORGANIZATIONAL MAINTENANCE INSTRUCTIONS

Section 1. GENERAL

5-1. Scope of Organizational Maintenance

Organizational maintenance of the radio sets include the following:

- a. Preventive maintenance (para 5-3, 5-4, and 5-5).
- b. Visual inspection (para 5-8 and 5-13).
- c. Troubleshooting (para 5-9, 5-10, and 5-12).
- d. Touchup painting (para 5-11).

5-2. Test Equipment, Tools, and Materials Required

a. Parts available for organizational maintenance of the radios are contained in TM 11-5820-498-20P

b. The following tools, test equipment, and materials are required:

- (1) Tool Kit, Electronic Equipment TK-101/G.
- (2) Multimeter, Digital AN/PSM-45 or Multimeter AN/URM-105 (Appx C).
- (3) Test Set, Radio AN/PRM-34(*) or Test Set RF Power AN/URM-182 (para 5-12).
- (4) Silicone compound (Appendix E).
- (5) Trichlorotrifluoroethane (Appendix E).

Section II. PREVENTIVE MAINTENANCE

5-3. Organizational Preventive Maintenance

Preventive maintenance is systematic care, inspection, and servicing of equipment to maintain it in serviceable condition, prevent breakdown, and assure maximum operational capability. Organizational preventive maintenance checks and services (PMCS) is conducted on a quarterly basis (para 5-4 and 5-5).

d. To inventory the assigned radio equipment (item 1, para 5-5), refer to appendix B for the radio components and to SB-11-131. For the rest of the component applicable to the radio and vehicle, refer to appendix D. Refer to paragraph 1-6b for clarification. Non-operational components include: Pack Frame, CW-503/PRC-25, (fig. 1-13), antenna tip cap, antenna tie-down assembly, and the steel reinforcing ring (issued with some AS1729/VRC's) (fig. 1-9 and 1-10).

5-4. Organizational Preventive Maintenance Checks and Services, General

a. Organizational PMCS will be scheduled using prescribed forms specified in DA Pam 738-750.

b. Cleaning, dusting, washing; stowing of components not in use; checking damaged cables; tightening all nuts and bolts holding the equipment and cables to the vehicle, and covering unused receptacles with dust covers (fig. 6-1) are not listed among the PMCS procedures. These things are taken care of as soon as the need is seen.

c. The PMCS procedures in paragraph 5-5 cover the radio sets and also the components required to make the radio sets operational. In tracked vehicles, these include the audio accessories and the vehicle electrical harness consisting of the control boxes (fig. 2-3), MT-1029/VRC, cables and mounting hardware. In wheeled vehicles (without radio-intercom system), these include the audio accessories, MT-1029/VRC, cables and mounting hardware.

5-5. Organizational Preventive Maintenance Checks and Services — Quarterly Schedule

NOTE

1. The *item No.* column in the following chart shall be used as source of item numbers for the *TM number* column on DA Form 2404 (Equipment Inspection and Maintenance Worksheet) in recording results of PMCS.
2. If the equipment fails to operate or the equipment does not meet the criteria specified in the *Procedures column* in the chart, report the failure in accordance with the procedures specified in DA Pam 738-750.
3. Select those items to be inspected that are authorized for the installation in which the radio is installed. For example: items 6, 14, and 15 are only provided in some vehicle installation.
4. The receiver/transmitter will be checked for RF output during this service using the AN/PRM-34 or equivalent test set.

Item No.	Item to be inspected	Procedure Check for and have repaired or adjusted, as necessary
1	Completeness	AU components required to make the radio operational are on hand (appx B) or available (para 5-4d).
2 3	Publications Modifications	TM 11-5820-498-12 is on hand with latest changes; see DA Pam 25-30 for current listing. Check DA Pam 25-30 to see if any modification work orders (MWO's) are listed against the radio or its components. AU URGENT MWO's must be applied immediately; all NORMAL MWO's must be scheduled.
4	Metal surfaces	Remove rust, corrosion, and fungus. Spot paint bare metal spots (pars 5-11).
5	Audio accessory (microphone, handset etc.) (fig. &2 and 6-3).	Apply a thin coating of silicone grease (app E) to the cable connector O-ring (not to the connector contacts).
6	Crewmember helmet (fig. 6-3, 6-3.1)	<ul style="list-style-type: none"> a. Apply a thin coating of silicone grease (app E)to the cable connector O-ring (not to the connector contacts). b. The microphone boom locks in desired position and the earphones are locked in position in the helmet. c. The switch assembly is secured to the helmet and the switch locks into the intercom and listening position and not in the radio position. d. Clean the inside and outside of the helmet (pars 4-3).
7	Antenna	<ul style="list-style-type: none"> a. The mounting bolts for the MX-6707/VRC (AS-1729/VRC) are just snug tight (100 inch lb, maximum). b. Remove the drain screw (located between J1 and J2 (fig. 30-3) to let out accumulated water; replace the screw. c. Separate the two antenna elements, clean the threads of the top section, AT-1095/VRC, and apply a thin coating of silicone grease (app E) to the threads.
8	Amplifier power supply (fig. 3-1).	<ul style="list-style-type: none"> a.The SET POWER and ANTENNA CONTROL covers are attached to the case. b. On the A-mcdel, the rubber cap is secured to the SPKR switch.
9	MT-1029/VRC (fig. 1:8).	<ul style="list-style-type: none"> c. Check the condition of the five resilient mounts (shock absorbers) by grasping the top tray of the MT-1029 and exerting sufficient force in different directions (up and down, side to side, back and forth) to disclose any excessive wear or damaged resilient mounts. a. Check the condition of the shock absorbers by pulling the amplifier power supply out about 5 inches and quickly pushing it back in to the mounting. The top tray should not move more than 1/4 inch. b. The bonding strap is secured to the top tray and the bottom plate. c. The rubber cover for the oval radio connector is attached to the mount, is not damaged, and can be attached securely to the connector. d. The clamps and guide pins are not damaged or missing. e. Clean out the drain holes next to the five mounting screws.
10	RT-841 PRC-77 or RT505TRC-25 (fig. 2-6)	<ul style="list-style-type: none"> a. The clamps are not damaged and they hold the CY-2562PRC-25 to the radio case. b. The pressure test screw is in place and epoxy (app E) is applied over the edge of the screw. c. Observe the case of the unit to see if there is evidence of bulging (due possibly to gas exploding in the case (pars 1-8e)). d. Check the following front-panel parts: <ul style="list-style-type: none"> (1) The four electrical connector covers (fig. 1-6) are attached to the front panel and each cover fits securely on its connector. (2) The present levers (fig. 3-7) function to lock and release the MC and KC controls. e. Clean out the receptacle in the antenna mount (fig. 1-6). Also, clean out the drain hole near the base of this antenna mount leading to the threaded antenna receptacle. Loosen the front panel captive screws (fig. 1-6), separate the front panel and chassis from the case, and perform the following checks:

Item No.	Item to be inspected	Procedure Check for and have repaired or adjusted, as necessary
		<p><i>f.</i> (1) Using lung power, blow out all parts on both sides of the case (to get rid of gasses that may have accumulated).</p> <p>(2) Inspect the battery connector for the following:</p> <p>(a) A rubber gasket (shaped similar to the metal ring around the battery connector hole RT-841/PRC-77 case) must be installed on the radio connector. It must be undamaged, be seated flush with the bottom of the connector (inside the four connector mounting screws), and flush with the body of the connector.</p> <p>(b) The two O-rings on the radio connector <i>must</i> be installed and undamaged (that is, they must not be sheared) and must be seated, under tension, in their grooves.</p> <p>(c) The three radio connector pins are not bent or loose, or otherwise damaged.</p>
11	DA Label 132	The label is in an attention-arresting place and is legible (para 2-5). Apply varnish, lacquer, or similar coat to the label.
12	CY-256/PRC-25 (fig. 2-6)	<p>a. Tighten the pressure relief valve, which must be installed (para 1-8e).</p> <p>b. Apply a light pressure of air to both sides of the pressure relief valve; air should not go through the valve when applied from the outside of the case and should when applied from inside the case.</p> <p>c. Clean out the CY-2562/PRC-25 (para 4-3).</p>
13	AM-1780/VRC (fig. 3-2)	The POWER indicator socket and lens cap are not loose and the lens can be rotated clockwise and counterclockwise.
14	C-2997VRC (fig. 3-4)	The SIG indicator socket and lens cap are not loose, and the lens can be rotated clockwise and counterclockwise.
15	C-2296/VRC (fig. 3-6)	<p>a. The call indicator lens is not damaged. The lamp socket is secured to the box on the vehicle and is connected to the C-2296/VRC.</p> <p>b. The handset receptacle in the box cover holds the handset securely and the box cover closes securely.</p> <p>c. -Clean out the box.</p>
16	MX-7778/GRC or MX-7778/GRC	<p>a. The mounting bolts are tight and the ground strap is installed across one of the bolts.</p> <p>b. The cap is installed on the unused connector.</p> <p>c. On the MX-7777A/GRC, the boot is installed undamaged over the ON-OFF switch.</p> <p>d. On the MX-7777B/GRC, the BATTLE OVERRIDE switch guard is in position and undamaged</p> <p>e. The resilient mounts are not hard, brittle, or cracked.</p>
17	Mini-suppressor (fig. 2-8; para 1-6b(3), (e)).	<p>a. The indicator lamp is not lighted (if it is, replace mini-suppressor (SB 11-638)).</p> <p>b. Tighten the indicator lamp bezel.</p> <p>c. Check that there is no evidence of melted solder around the diode and washer, and that the nut on the washer is not loose,</p> <p>d. Clean the heatsink surfaces.</p>
18	Pack Frame LC-2 and CW-503/PRC-25 (fig. 2-4) (part of AN/GRC-125 and AN/GRC-160) .	<p>a. All metal parts are secured to the canvas assembly.</p> <p>b. Canvas areas are not torn and all straps are attached securely to the canvas assembly.</p>
19	AT-892/PRC-25 (p/o AN/GRC-125 and AN/GRC-160) (fig. 1-13).	<p>a. The bottom section holds the upper section firmly in position when the upper section is bent at various angles.</p> <p>b. The threaded connector is securely attached to the bottom section.</p> <p>c. Apply a thin coat of silicone grease (app E) to the threaded connectors.</p>
20	AT-271A/PRC and AB-591A/PRC-25 (p/o AN/GRC-125 and AN/GRC-160) (fig. 1-13).	<p>a. The wire running through the sections is not broken or frayed. There is no water in the sections.</p> <p>b. When full extended and assembled, each section fits into the next section.</p> <p>c. The tip cap is in place.</p> <p>d. Apply a thin coat of graphite grease (app E) to the threaded connectors.</p>

5-6. Replacement of Gaskets

CAUTION

- When applying silicone compound, be careful not to let the compound touch electrical contacts.

When the gaskets are replaced or signs of moisture leakage is apparent, a light coating of an silicone compound should be used to provide a suitable moisture seal. Use Silicone Compound, Dow Corning DC4 (app E), for this purpose.

5-7. Setting Position of INSTALLATION

**SWITCH on Amplifier, Audio Frequency
AM-1780/VRC**

(fig. 3-2)

The INSTALLATION SWITCH is set according to the type of installation in which the AM-1780/VRC is used.

- a. When there is no radio equipment provided for communication in association with the intercom equipment, set the INSTALLATION

SWITCH to INT ONLY. In this condition, power for the intercom system would be applied to connector J508 (fig. 2-3).

b. When there are two radios in the vehicle and they are to act as a relay in a communication net, set the INSTALLATION SWITCH to RETRANS. In this situation, a relay box, Control, Radio Set C-2299/VRC would be in-

terconnected between connectors J509 and J511; one radio set would be connected to connector J501, and the other radio connected to J503.

c. In any other system configuration, set the INSTALLATION SWITCH to OTHER. This is the case for the intercom installations with which the radio is used (fig. 2-3).

Section III .TROUBLESHOOTING

5-B. Visual Inspection

a. Before operating the equipment for troubleshooting purposes, inspect it for visible defects. This saves repair time and may prevent further damage. Do not inspect any item with the power on. Inspect the following for obvious defects:

- (1) The seating of all connectors.
- (2) Cracked or broken printed wiring boards.
- (3) Main frame wiring dress for possible shorts (especially after handling or repairing the equipment).

b. If the visual inspection does not locate the trouble, proceed to the troubleshooting chart (para 5-9).

5-9. Troubleshooting

a. *General* When the equipment failure is unknown, use the operational checks in the operator's daily, preventive maintenance checks and services (para 4-4); for man-pack operation, use sequence No. 3a through 3d; for

vehicular operation, without intercom, use sequence No. 4a through e; for vehicular operation with intercom, use sequence numbers 5a through p.

b. *Procedure.* Before using the following charts (c, d, or e below), perform the checks given in the operator's troubleshooting chart (para. 4-8).

- (1) When the receiver-transmitter is defective, refer it to higher maintenance category for troubleshooting and repair.
- (2) To test the amplifier-power supply, a MT-1029/VRC with a vehicular battery or equivalent source of 22 to 28 volts dc (such as Power Supply PP-2953/U) and a receiver-transmitter with an antenna are required.
- (3) When an item substitution is recommended, use an item known to be good. After the substitution, check the equipment for proper operation.

c.. *Man-pack Operation.*

Indication	Probable trouble	Procedure
Unable to transmit or receive -----	a. Defective receiver-transmitter -- b. Defective handset -----	a. Refer to higher maintenance for troubleshooting. b. Refer to TM 11-5985-257-15 for maintenance and repair parts of the H-138(*)/U. Refer to TM 11-5985-280-15 for maintenance and repair parts of the H-189/GR.

d. Vehicle Operation—Not Provided with Intercom System.

Item No.	Indication	Probable trouble	Procedure
1	Unable to transmit or receive.	<p>a. No dc power applied to MT-1029/VRC.</p> <p>b. Defective amplifier-power supply.</p>	<p>a. Check vehicular battery to determine its voltage. Make the measurement at the vehicular battery terminals with the vehicle engine at idle and accelerated. The voltage indication should be between 22 and 28 volts dc.</p> <p>(1) Remove the battery cable CX-4720/VR (fig. 2-3), from the MT-1029/VRC. Measure vehicle battery voltage between pins B (+) and A (-) (C, fig. 5-1) of the cable connector. If positive voltage is obtained at pin A, reverse the connections of the cable on the vehicle battery.</p> <p><i>Note.</i> When the battery polarity has been reversed, usually the amplifier-power supply is damaged, or some pins in J24 of MT-1029/VRC (fig. 5-1) are destroyed.</p> <p>(2) If the battery voltage indications are correct, reconnect the cable to the MT-1029/VRC, and measure the vehicle battery voltage between pins B (+) and A (-) of cable connector J24 on the MT-1029/VRC (C fig. 5-1). If the vehicle battery voltage is not obtained, check the fuse in the junction box of the MT-1029/VRC. If the fuse is good, refer the MT-1029/VRC to higher maintenance category for troubleshooting.</p> <p>b. On the AM-2060/GRC, set the PWR switch to ON and check the output voltages of the amplifier-power supply (para 5-10).</p> <p>If voltage indications are incorrect, refer the amplifier-power supply to higher maintenance category for troubleshooting.</p> <p>If the voltage indications are correct, replace the CX-4655/GRC on the SET POWER connector on the amplifier power supply. Measure the voltages in the cable connector at the same pin terminals as listed for the SET POWER connector (A, fig. 5-1). If voltage indications are incorrect, replace the CX-4655/GRC; if the voltage indications are still correct, check the receiver-transmitter (c below).</p>

Item No.	Indication	Probable trouble	Procedure
		c. Defective receiver-transmitter	Refer to higher maintenance for troubleshooting.
		d. Defective handset	d. Substitute the handset. Refer to TM 11-5965-257-15 for maintenance and repair parts of the H-138(*)/U. Refer to TM 11-5965-280-15 for maintenance and repair parts of the H-189/GR.
		e. Defective antenna system	e. Substitute the CX-4722/VRC. In the AT-912/VRC, substitute the AB-719/VRC, (fig. 1-9); in the AS-1729/VRC, substitute the MX-6707/VRC (fig. 1-10).
2	No output from the loudspeaker of the amplifier-power supply.	Defective amplifier-power supply NOTE: Insure the CX-4655/VRC has been tested in accordance with item No. 1b.	Refer the amplifier-power supply to higher maintenance category for troubleshooting.

e. Vehicle Operation—Provided with Intercom System.

Item No.	Indication	Probable trouble	Procedure
1	Unable to communicate on radio from any crewmember control box.	a. Defective audio accessory b. Defective MT-1029/VRC, amplifier-power supply, or receiver-transmitter. c. Defective cable or crewmember control box.	a. Substitute audio accessory. Refer to publication covering the audio accessory (para 6-5 through 6-8). b. Connect an audio accessory to AUDIO connector on the receiver-transmitter. If radio communication is unsatisfactory, refer to item 1, d above. If radio communication is satisfactory, proceed to c below. c. Connect an audio accessory to each crewmember control box. Set up all equipment to provide radio communication from the crewmember control boxes. Proceed as follows: (1) While attempting to establish radio communication at each crewmember control box, remove, in turn, the cable from the AM-1780/VRC (fig. 2-3) to each crewmember control box. (2) When radio communication is restored, substitute the cable which removal restored radio communication. (3) If radio communication ceases when the cable is connected to the crewmember control box, substitute the crewmember control box.

e. Vehicle Operation—Provided with Intercom System—Continued

Item No.	Indication	Probable trouble	Procedure
2	Unable to transmit or receive on radio from one crewmember control box.	c. Defective cable or crewmember control box—continued. a. Defective audio accessory ----- b. Defective cable or control box --	(4) When substitution of the crewmember control box does not restore communication, substitute the AM-1780/VRC. a. Substitute the audio accessory. Refer to publications covering the audio accessory (para 6-5 through 6-8). b. Substitute the cable between the AM-1780/VRC and the particular crewmember control box (fig. 2-3). Substitute the control box.
3	Unable to communicate on intercom from any crewmember control box.	Defective cable or control box -----	Use the procedures given in item 1c above, except set up the crewmember to communicate on intercom and make the communication checks on the intercom system.
4	Unable to communicate between the C-2297/VRC and C-2296/VRC or intercom.	Defective cable or crewmember control box.	Substitute the CX-7055/VRC or CX-7057/VRC (fig. 2-3), and CX-7056/VRC. Substitute the C-2297/VRC and C-2296/VRC. Require that vehicle interconnection system between the C-2297/VRC and C-2296/VRC be checked for defective connections.

5-10. Amplifier-Power Supply Output Voltage Checks
(fig. 5-1)

Check the voltage output of the amplifier-power supply as follows:

a. Remove Cable Assembly, Special Purpose, Electrical CX-4655/GRC from the amplifier-power supply SET POWER connector.

■ b. Connect Multimeter AN/URM-105 negative test lead to the rim of the amplifier-power supply SET POWER connector (A, fig. 5-1).

c. Place the AN/URM-105 positive test lead to the pins on the amplifier-power supply SET POWER connector (A, fig. 5-1) as indicated in the chart below.

AN/URM-105 positive test lead connection	(dc) Normal voltage
Pin E -----	13 volts
Pin H -----	25.5 volts*
Pin M -----	3 volts

d. Remove the AN/URM-105 test leads from the SET POWER connector and replace the CX-4655/GRC.

*Vehicle battery voltage. With RT-505/PRC-25 connected and keyed, voltage would be 2.6 volts.

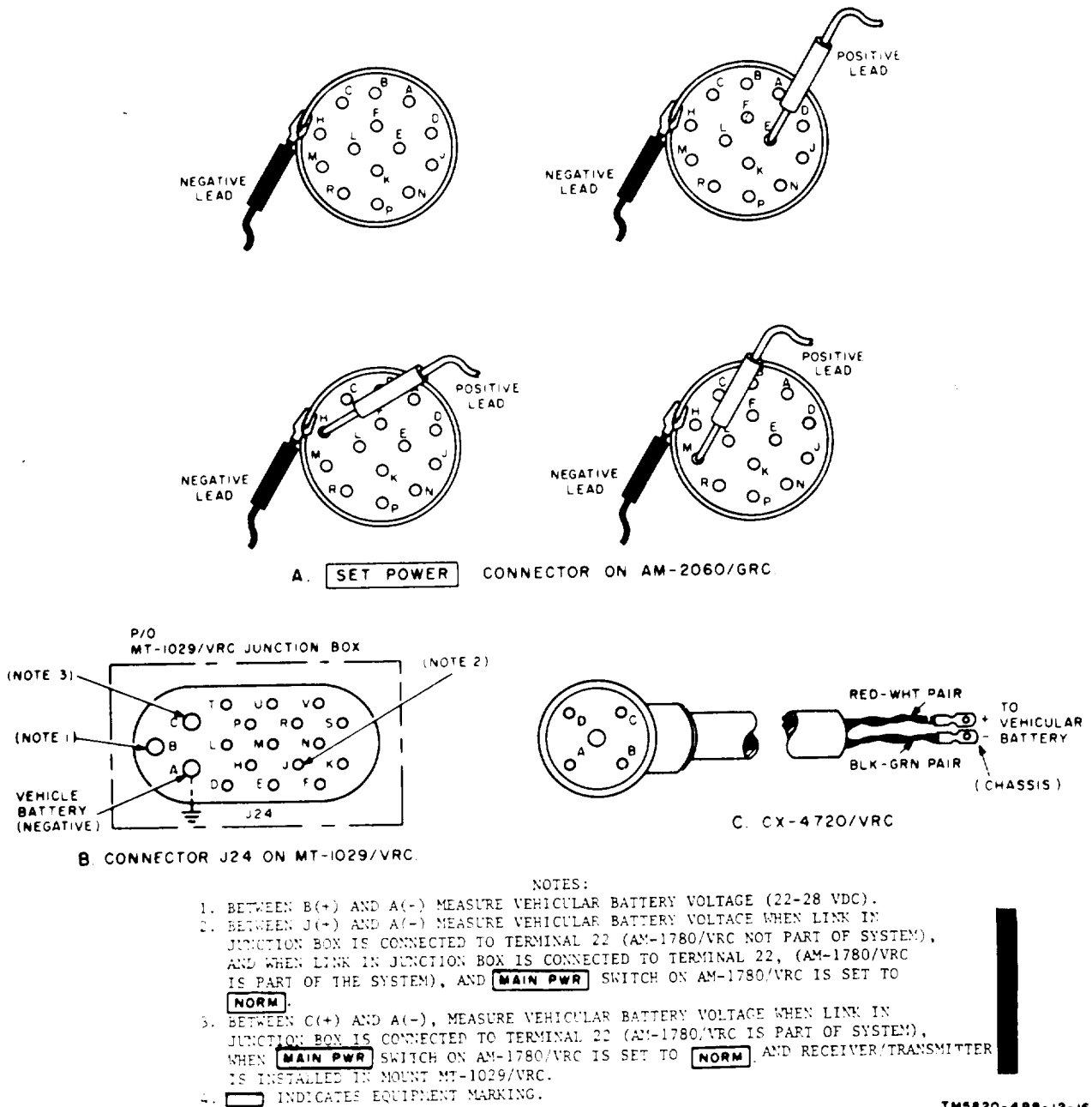

Figure 5-1. Output voltage test points on SET POWER connector on amplifier-power supply, J24 on MT-1029/VRC, and CX-4720/VRC.

5-11. Touchup Painting

Remove rust and corrosion from metal surfaces by lightly sanding them with fine sandpaper, Brush two thin coats of paint on the

bare metal to protect it from further corrosion. Refer to the applicable cleaning and refinishing practices specified in SB 11-573 and TB 43-0118.

5-12. Use of Test Set, RF Power ANAJRM-182

The AN/URM-182 is a small, 50-ohm impedance, throughline RF wattmeter (para 5-2c) that measures forward and reflected RF power in 30- to 76-MHz range up to 100 watts. It has little effect on received signal power. To use the AN/URM-182, proceed as follows:

a. To test the radio output and the antenna system, use the following procedures:

(1) Disconnect the antenna cable connection at the receiver-transmitter (fig. 2-3) and connect the AN/URM-182 between the receiver-transmitter and the antenna cable. Let the vehicular whip antenna stand upright. (When the antenna is tied down, the forward and reflected power indications are different from those obtained when the antenna is standing upright.)

(2) Connect an audio accessory to the radio and key the transmitter by operating the audio accessory to radio position. Observe the AN/URM-182 for forward and reflected power indications.

(3) Forward power indication for the RT-505/PRC-25 should vary with frequency changes from .5 to 3 watts; forward power indication for the RT-841/PRC-77 should vary with frequency changes from .5 to 4 watts. The variations in output power are dependent on the frequency being used.

(4) Using the forward and reflected power readings, refer to the "power values versus swr (standing wave ratio)" charts in TM 11-6625-1686-15 to compute the swr of the antenna system under test. *The swr for the AT-912/VRC and AS-1729/VRC should be no more than 3.* For example, with a forward power indication of 2 watts, the reflected power indication should be no more than .5 watt. (This combination is a swr of 3.)

(5) If the swr is more than 3 for the AT-912/VRC or AS-1729/VRC, one of the following items is at fault and should be replaced:

(a) If the forward power indication is low, check the forward power for other frequencies in the radio band. If the indication is still low, the receiver-transmitter is at fault.

CAUTION

Never change frequencies or the BAND switch *while the radio is keyed*. Make the changes while the radio is not keyed. The RT-841/PRC-77 is especially susceptible to module damage if the frequency of the BAND switch is changed while the radio is keyed.

(b) If the swr is more than 3 for the AT-912/VRC or AS-1729/VRC, one of the antenna items is at fault and should be replaced until the swr is not more than 3. Following are items to be checked:

1. The top antenna section is loose (AT-1095/VRC).

2. The bottom antenna section (AT-1096/VRC or AS-1730/VRC) is loose; or the spring contact in the bottom section is defective.

3. The setscrews that hold the connector at the top of the matching unit (fig. 4-1) are loose allowing the connector to fall down into the spring section.

4. The wires of the white-covered cable *inside* the spring of the matching unit are damaged; usually by being pinched by the spring. (In some matching units, this cable is manufactured too long and should be replaced by a cable of the proper length.)

5. The CG-1773/U is not tightly locked on the matching unit receptacle (fig. 2-3).

6. The CG-1773/U is defective.

7. An antenna cable other than the CG-1773/U is being used. Only a 50-ohm impedance RF cable (RG-58/U or RG-8/U) should be used.

8. In the MX-2799/VRC of the AT-912/VRC, a circuit card for the frequency being used is defective.

9. In the MX-6707/VRC of the AS-1729/VRC, a circuit is defective.

10. The control cable, CX-4722/VRC (fig. 2-3), is not properly tightened at the radio or the matching unit. Take the cable off at both ends and check to see that the male pins on the cable end and the male pins on the matching unit are not bent or damaged. Without keying the radio, change the receiver-

transmitter BAND switch and run the mc control through its full range in one of the bands. The relay in the matching unit should be heard operating when the BAND switch is changed and at approximately every 5 mc. On the .MX-6707/VRC, the range screw should be seen moving to each of its positions as the mc control is changed.

b. To test the radio without the antenna system, use the following procedures. A 50-ohm impedance dummy load is required to terminate the ANURM-182.

(1) Connect the ANURM-182 to the antenna receptacle or the receiver-transmitter. Connect a 50-ohm impedance dummy load to the AN URM-182

(2) (Connect an audio accessory to the radio and key the transmitter by operating the audio accessory to radio position. Observe the meter for a forward Power indication. (A reflected power indication is imperceptible if any, and does not help in checking the transmitter power output.) Stop keying the radio and change to another mc frequency.; key the radio again. Continue through the mc frequency band checking random frequencies.

CAUTION

Never change the frequency or the BAND switch while the radio is keyed.

(3) The RT-505 PRC-25 should indicate between .5 and 3 watts; the RT-841/PRC-77 should indicate between .5 and 4 watts. The indication obtained changes as the radio frequency is changed.

(4) Obtaining no output power indication or consistently low indications for most frequencies indicates that the transmit or synthesizer circuits in the receiver transmitter are defective.

5-13. Inspecting Receiver-Transmitters for Condition of Hydrogen Gas Protection Devices

Perform the following operations periodically

(item 7, para 5-5) to purge hydrogen gas (*b* below) that may accumulate in the chassis from the magnesium battery (para 1-8e), and to inspect the items that help prevent hydrogen gas from leaking into the chassis (*c*, *d*, and *e* below). When any item in *c*, *d*, or *e* below is defective, it must be corrected before the radio can be used for man-pack communication.

a. Stand the receiver-transmitter on its front panel (fig. 2-6). Remove the CY-2562/PRC-25 (and the battery if used), Loosen the captive screws and pull the case from the receiver-transmitter.

b. Blow out all parts on both sides of the receiver-transmitter chassis. Use lung power.

c. Inspect the receiver-transmitter battery connector for the following:

(1) Rubber gasket (NSN 5330-01-049-0038) (shaped similarly to the metal ring around the battery connector hole in the receiver-transmitter case) must be installed on the receiver-transmitter battery connector. It must be undamaged, be seated flush with the bottom of the connector (and inside the four connector mounting screws), and flush with the body of the connector.

(2) The two O rings on the battery connector must be installed and undamaged. That is, they must not be steared, and each O ring must be seated, under tension, in its recess.

(3) The three battery connector pins must not be bent or otherwise damaged.

d. In the receiver-transmitter case (fig. 2-6), the pressure test screw must be screwed tightly, and covered with an epoxy (NSN 8040-00-753-4800, or equivalent) to insure that it is sealed and cannot be loosened. (The hole was used in manufacture for pressure test instruments.)

e. In the CY-2562/PRC--25 (fig. 2-6), the pressure relief valve must be installed (para 1-8e. Check to see that it is screwed together; use a wrench to tighten the pressure relief valve nut on the inside of the CY-2562/PRC-25.

CHAPTER 6

MATERIEL USED IN CONJUNCTION WITH RADIO SETS

Section I. AUDIO AND INTERCOMMUNICATION EQUIPMENT

NOTE

Intercommunication Set AN/VIC-1 (V) includes AM-1780/VRC and 2 to 4 C-2298/VRC's; it may also include one C-2297/VRC and one C-2296/VRC. Refer to paragraph 1-6b for components to make the radio sets (para 1-6a) operational.

6-1. Amplifier, Audio Frequency AM-1780/VRC
(fig. 6-1)

The AM-1780/VRC is a component of certain installation kits. It amplifies the intercom and radio receiver outputs and is the main junction box of a radio system installed in a vehicle or crew-served weapon. All operating controls and connectors are external. Ten connectors are located on the top, bottom, and sides. Operating controls, an indicator lamp, and two pairs of binding posts are located on the front. Eight captive screws attach a gasket-sealed cover to the rear of the AM-1780/VRC. The cover has four mounting lugs that are used to mount the AM-1780/VRC. Operation of the AM-1780/VRC is covered in paragraphs 3-3 and 3-15.

6-2. Control Intercommunication Set C-2296/VRC
(fig. 6-1)

The C-2296/VRC is a component of certain installation kits. It provides communication on the radio set and between personnel inside outside a vehicle or crew-served weapon. It has Handset H-207/VRC connected at the right side. A power and control cable connector and a signal lamp connector are located on the sides. Operating controls and a pair of binding posts are located on the front. Four captive screws attach a gasket-sealed cover to the

rear of the C-2296/VRC. The cover has two mounting lugs for use in installing the C-2296/VRC on the outside or shell of a vehicle or crew-served weapon. Operation of the C-2296/VRC is covered in paragraphs 3-7 and 3-16.

6-3. Control, Intercommunication Set C-2297/VRC
(fig. 6-1)

The C-2297/VRC is a component of certain installation kits. It provides communication on the radio set and communication between crew-members of a vehicle or crew-served weapon. It usually is mounted at the driver's location. It is also used to connect a C-2296/VRC to the radio and intercom systems. All operating controls and connectors are external. Power and control cable connectors are located at the sides. Audio accessory connectors and a VOLUME control are located on the bottom. An indicator and the remaining operating control are on the front. Four captive screws attach a gasket-sealed cover to the rear of the C-2297/VRC. The cover has two mounting lugs for use in installation. Operation of the C-2297/VRC is covered in paragraphs 3-5 and 3-17.

6-4. Control, Intercommunication Set C-2298/VRC
(fig. 6-1)

The C-2298/VRC is a component of certain

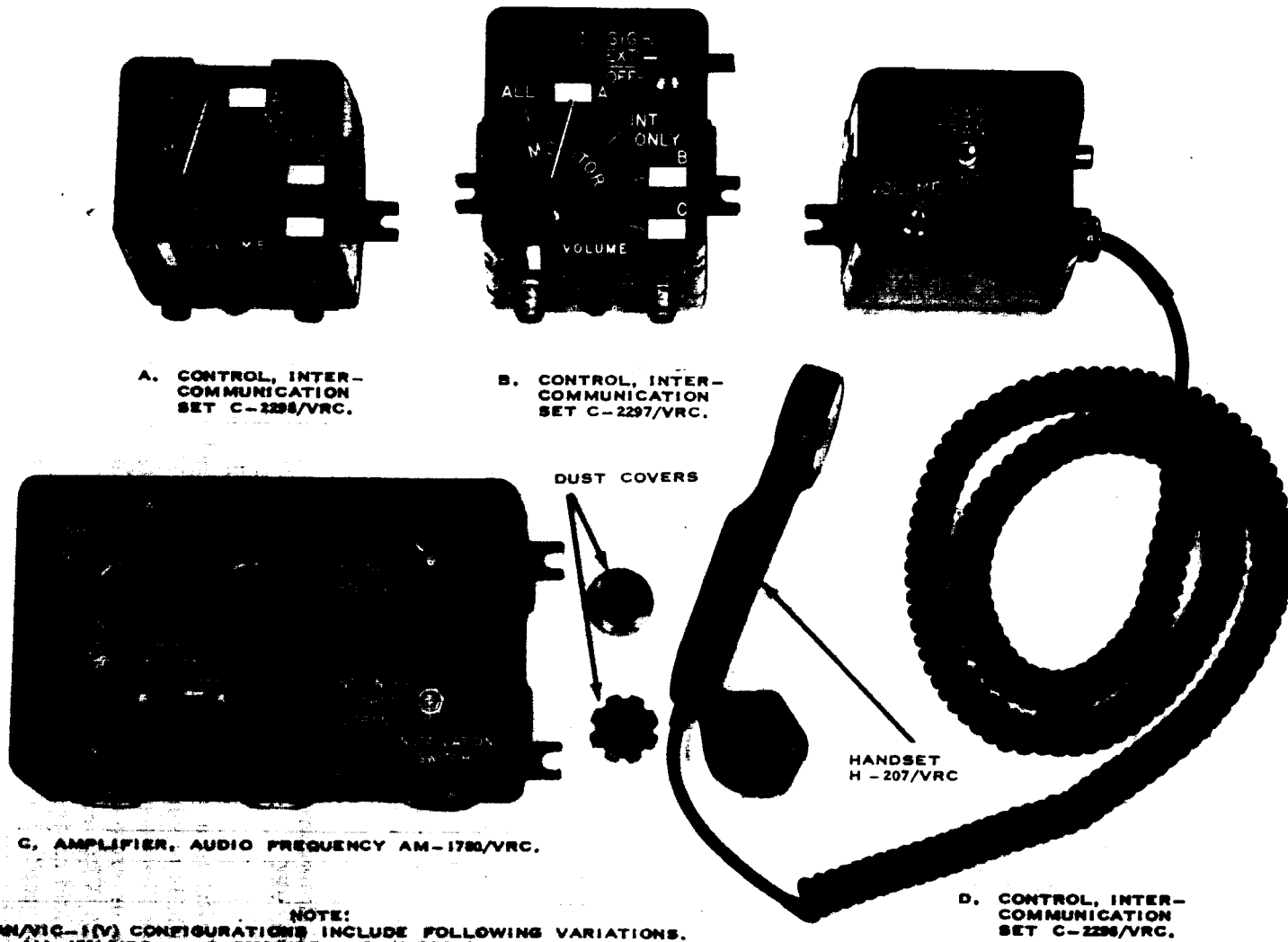

NOTE:
AN/VIC-1(V) CONFIGURATIONS INCLUDE FOLLOWING VARIATIONS.

AM-1780/VRC	C-2296/VRC	C-2297/VRC	C-2296/VRC
1	2, 3, OR 4	NONE	NONE
1	2, 3 OR 4	1	1

EL 5820 - 401 - 12 - TM - 57

Figure 6-1. Intercom equipment, AN/VIC-1(V).

installation kits. It provides communication on the radio set and between crewmembers or commander of a vehicle or crew-served weapon. All operating controls and connectors are external. Power and control cable connectors are located at the sides. Audio accessory con-

nectors and a VOLUME control are located on the bottom. Four captive screws attach a gasket-sealed cover at the rear of the C-2298/VRC. The cover has two mounting lugs for use in installation. Operation of the C-2298/VRC is covered in paragraphs 3-6 and 3-18.

Section II AUDIO ACCESSORIES AND MINOR COMPONENTS

6-5. Headset, Electrical H-140A/GR (fig. 6-2)

The H-140A/GR (TM 11-5965-260-15P) is part of the installation kit for certain vehicles. It is used for listening to the radio and intercom system. It includes a pair of earphones, and a cord with a five-terminal connector.

6-6. Headset-Chestset, Electrical H-141/GR (fig. 2-3)

The H-141/GR is part of the installation kit for listening and speaking on the radio and intercom system. It has a pair of earphones, microphone, a switch assembly, and a cord assembly with two five-terminal connectors.

6-7. Headset-Microphone H-161/GR

The H-161/GR (TM 11-5965-262-13) is part of the installation kit for certain vehicles. It

is used for listening and speaking on the radio and intercom system. It has a pair of earphones, microphone mounted on a boom, a chest harness and switch assembly, and a cord assembly with two five-terminal connectors.

6-8. Microphone, Dynamic M-80/GR (fig. 6-2)

The M-80/GR is part of the installation kit for certain vehicles. It is used for speaking on the radio system. The microphone has a push-to-talk switch and a cord with a five-terminal connector.

6-9. Field Telephone and Wire

Field telephones, such as Telephone TA-312/PT, and field wire, such as Wire WD-1/TT, can be used with the radio sets to connect the intercom facilities of a vehicle with other installations.

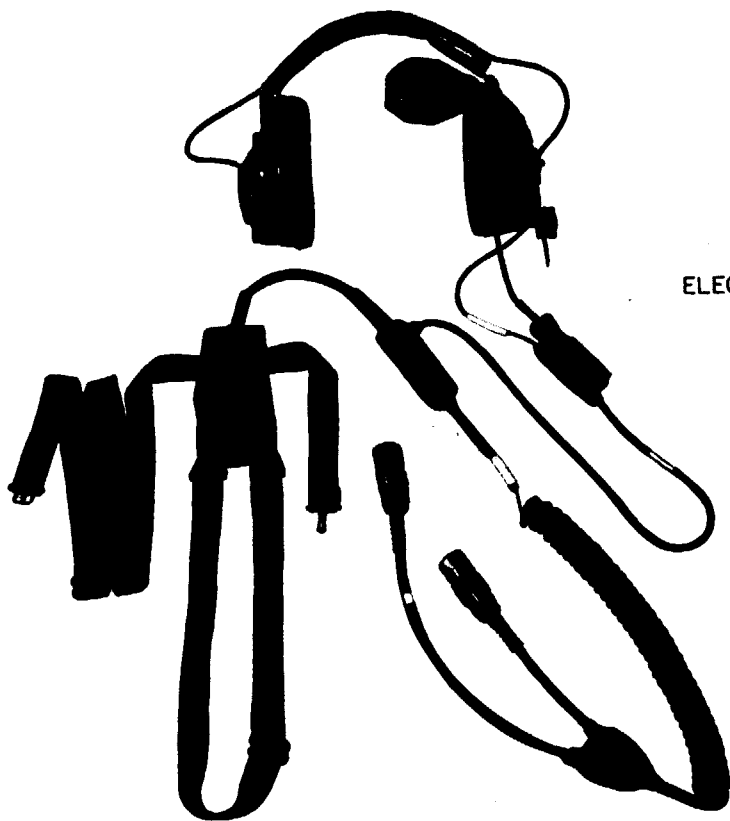

HEADSET-MICROPHONE H-161/GR

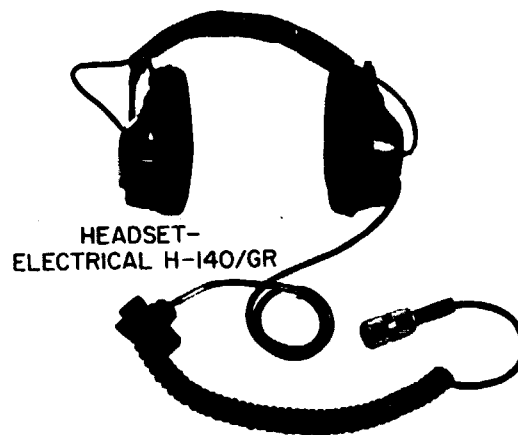

HEADSET-
ELECTRICAL H-140/GR

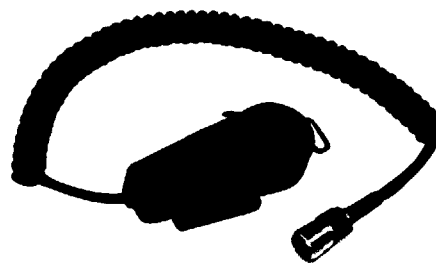

DYNAMIC MICROPHONE M-80/GR

TM 5820-498-12-9

Figure 6-2. Audio accessories.

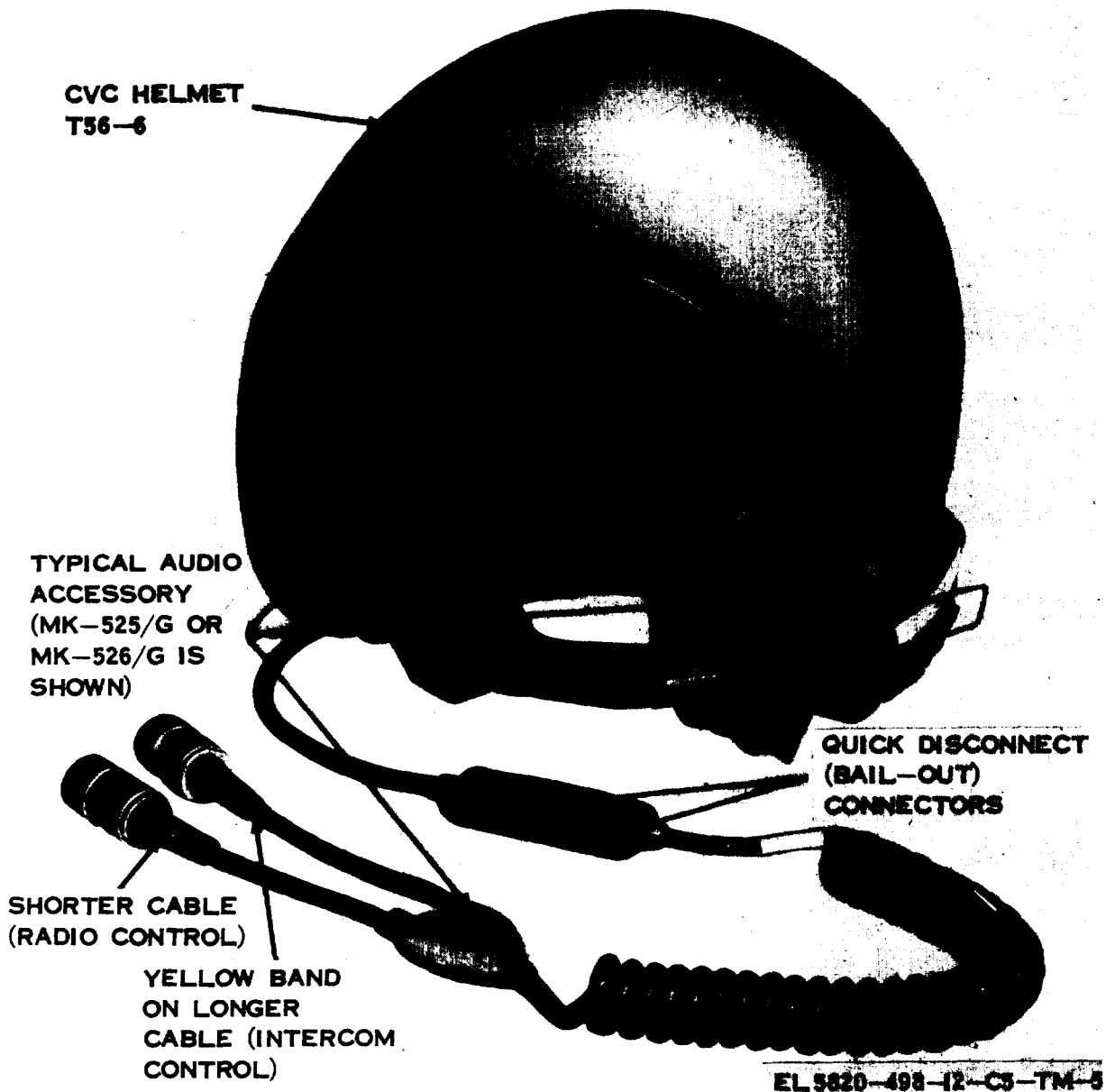

Figure 6-3. CVC helmet with typical audio accessory.

6-10. Combat Vehicle Crewman (CVC) Helmet and Automotive Vehicle Crewman (AVC) Helmet

a. CVC helmet (type T56-6; fig. 6-3 is provided with Headset-Microphone Kit MK-1039/G (TM 11-5965-282-15). AVC helmet (type DH-132; fig. 6-3.1) is provided with Headset-Microphone Kit MK-1697/G (TM 11-5965-286-14).

b. The kits are used for listening and talking on the radio and intercom systems of the vehicle.

Each kit has cushioned earphones, and adjustable microphone boom assembly, and a switch assembly. The microphones are noise-canceling type requiring the user to talk with the lips close to the microphone. The retractile cord is connected to the assembly through a quick-disconnect connector and terminated in two, five-pin connectors. The longer cord connector is for intercom use; the shorter is for radio use. Maintenance of the helmets is provided in TM 10-8400-201-23.

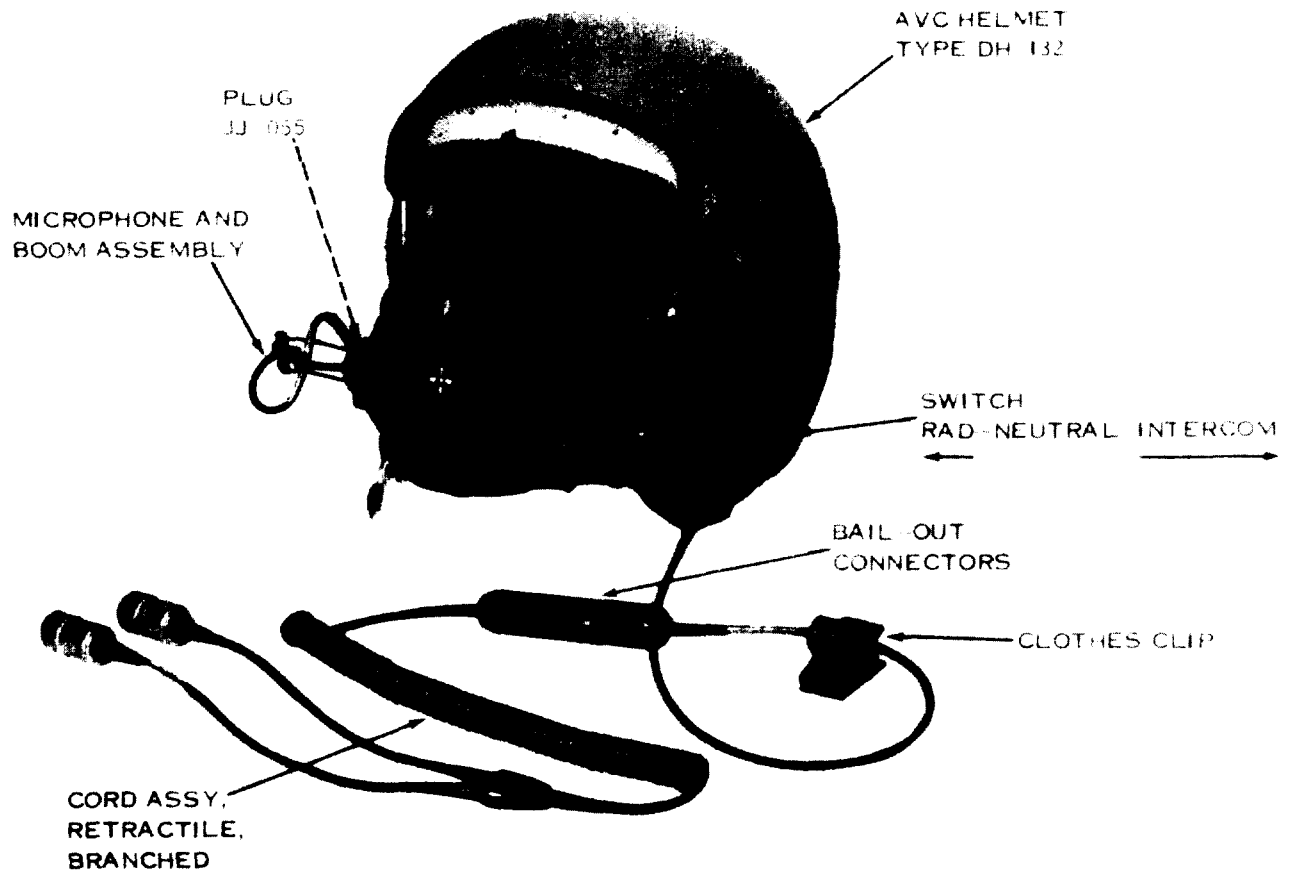

EL5820-498-12-TM-C8-1

Figure 6-3.1 AVC helmet with typical audio accessory

Section III. OTHER EQUIPMENT USED WITH RADIO SETS

6-11. Batteries, Dry BA-4386/U and BA-5598/U

a. The BA-4386/PRC-25 is a magnesium battery replacing the BA-386/U originally used in the equipment. Under normal use, BA-4386/U will operate the radio approximately 20-30 hours of normal transmit-receive use. The BA-4386/U does not require refrigeration before it is used, but when it has been in use approximately 5 hours (approximately 10 percent of its power used) and it is removed from the radio, store the battery in a cool moisture-flee area. This procedure will prolong its useful life. See SB 11-6 for battery requisitioning requirements.

WARNING

Observe the following procedures to dispose of a wornout battery:

Do not compact or incinerate the battery.

Do not dispose of the battery in streams, rivers, or oceans, etc. Shipboard users will retain the battery for shore disposal.

Turn in the wornout battery, accompanied by a completed DD Form 1348-1, to the local Defense Reutilization and Marketing Office (see DOD 4160.21-M).

b. Battery., Dry BA-5598/U is a lithium battery used in the equipment. It is intended to replace both the magnesium battery and the BA-398/U which was used in arctic conditions. Physically, the BA-5598/U is 1/2 the length of the magnesium battery and has a normal operating use of approximately 45 hours. It is recommended that 2B-A-5598/U batteries be carried in the Battery Box CX-2562/PRC-25 as no filler is provided. An additional benefit is quick availability of a spare battery.

NOTE

Two pads must be added to the battery case to provide proper support for the batteries.

WARNING

When storing lithium batteries, be sure to keep a type D fire extinguisher handy. If a lithium battery catches fire, never attempt to put out the fire with a Halon fire extinguisher. Halon and lithium, when mixed, produce toxic fumes. Turn in the damaged battery to the DRMO for disposal.

Do not leave the battery near other hazardous materials, such as flammable liquids and oxidizers. These materials could cause a bad chemical reaction with the lithium battery. In case of venting, inform your local safety office immediately.

Never use a voltage tester or the AN/PSM-13 battery tester on a lithium battery. Touching the battery with a tester adapter could cause the battery to vent toxic sulfur dioxide if the battery should short circuit. Using the tester could also ruin fuses as well as the battery cry.

Observe the following procedures to dispose of a wornout battery:

Do not compact or incinerate the battery.

Do not dispose of the battery in streams, rivers, or oceans, etc. Shipboard users will retain the battery for shore disposal.

Turn in the wornout battery, accompanied by a completed DD Form 1348-1, to the local Defense Reutilization and Marketing Office (see DOD 4160.21-M).

c. To test the magnesium battery BA-4386/U, use Battery Tester TS-183/U (TM 11-6625-450-15) or Test Set, Battery AN/PSM-13 TM 11-6625-823-15). No text is available for the lithium battery.

6-12. Radio Set Control Group AN/GM-39(*)

Note. Radio Set Control Group AN/GRA-39(*) represents AN/GRA-39, AN/GRA-39A, and ANIGRA-39B; Control, Radio Set C-2328(*)/GRA-39 (remote control) represents C-2328/GRA-39, C-2328A/GRA-39, and CX-328B/GRA-39; Control, Radio Set C-232P(*)/GRA-39 (local control) represents C-2329/GRA-39, C-2329A/GRA-39, and C-2329B/GRA-39.

The AN/GRA-39(*) may be used to provide remote radiocontrol of radio transmission and reception of the receiver-transmitter up to approximately 2 miles (3.3 km approx) (a below). This equipment may also be used to provide radio/wire integration (RWI) between Switchboard, Telephone SB-22/PT (TM 11-5805-262-12) and the receiver-transmitter (*b below*). Installation and operating instructions for the AN/GRA-39(*) are provided in TM 11-5820477-12.

a. *Remote Radio Control.* Operation of the radio sets described in paragraphs 3-8 through 3-19 are unchanged, except as follows:

- (1) When the AN/GRA-39 or AN/GRA-39A is used and its local control, C-2329/GRA-39 or C-2329 A/GRA-39, has not been modified by the application of MWO 11-5820-477-30/1 to permit use of the function switch on the receiver-transmitter in the SQUELCH position, the radio communication must be conducted with the function switch set to ON position only. In turn, the distant radio set in the net must also operate without squelch operation (para 3-12c).
- (2) When the AN/GRA-39B (in which the local control box, C-2329B/GRA-39 is used) or when the local control box of the AN/GRA-39 or AN/GRA-39A ((1) above) has been modified, the receiver-transmitter function switch may be set to SQUELCH.

- (3) If the radio reception is cutting in and out (caused by receiver-to-transmitter feedback loop that causes relay in the receiver-transmitter to alternate between receive and transmit positions), set the receiver-transmitter VOLUME control down to a position at which interruption of the signal ceases.

b. *Radio/Wire Integration (RWI).* To provide RWI between the receiver-transmitter and an SB-22/PT, using the AN/GRA-39(*), proceed as follows:

- (1) Connections.
 - (a) Prepare a Connector, Plug U-182/U (FSN 5935-823-0663; part of H-138(*)/U) or U-229/U (FSN 5935-173-8537; part of H-189/GR) with two jumper wires soldered to pins A and C (keying circuit).
 - (b) Locate the C-2328 (*)/GRA-39 remote control at the SB-22/PT and connect the equipment as shown in A, figure 6-4.
- (2) *Operation.* Since the remote control, C-2323(*)/GRA-39, is set up at the switchboard, the switchboard operator will respond to calls from the distant radio station using the push-to-talk radio position of his headset-chestset, and use correct radio communication procedures and call signs. In effect, the switchboard operator becomes the radio operator.
 - (a) Set the receiver-transmitter function switch and VOLUME control as given in a(1), (2), and (3) above.
 - (b) Set the switches on the AN/GRA-39(*) control boxes as shown in A, figure 6-4.
 - (c) When the radio call sign is heard on the loudspeaker of the remote control, C-2328(*)/GRA-39, insert the operator's cord into the radio link jack and determine the desired subscriber. Advise the distant radio station to standby while making the arrangement in 1 and 2 below.

(Also, refer to B, figure 6-4.)

1. Connect the operator's cord to the subscriber's jack, ring, and notify the subscriber of the call signs and to ring back when the call is completed.

2. Connect the subscriber's cord to the radio link jack.

NOTE

Operation of the switchboard headset-chestset switch to push-to-talk *radio* position, while the operator's cord is

connected to the subscriber's jack, will key the radio.

(d) Remove the operator's cord from the subscriber's jack.

(c) The incoming radio communication can be heard on the remote control loudspeaker; the subscriber's cannot be heard.

(f) When the subscriber's signal indicator shows white, insert the operators cord into the subscriber's jack and challenge the circuit without operating the headset-chestset switch to the push-to-talk *radio* position.

(g) Remove the subscriber's cord from the radio link jack.

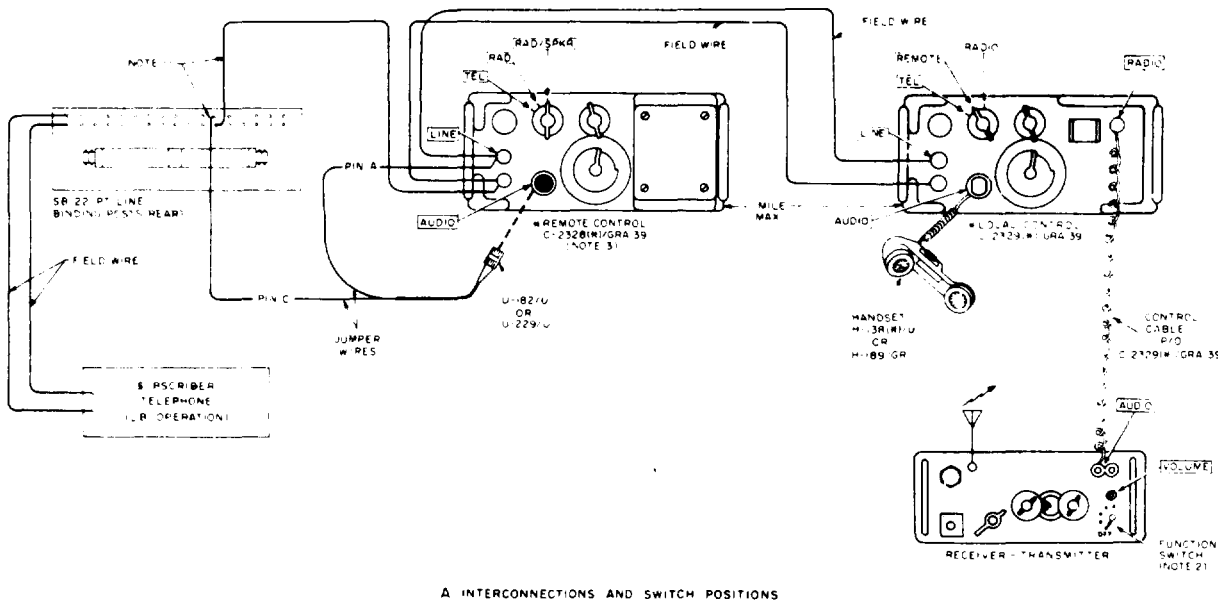

A INTERCONNECTIONS AND SWITCH POSITIONS

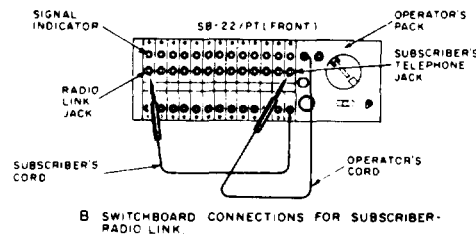

B SWITCHBOARD CONNECTIONS FOR SUBSCRIBER-RADIO LINK

NOTES

- * PART OF AN/GRA 39(1)
- 1 IF RECEIVER-TRANSMITTER IS KEYS TRANSPOSE CONNECTION OF THESE WIRES AT SB-22/PT
- 2 [SQUELCH] POSITION MAY BE USED WHEN C-2329B/GRA 39 IS USED, AND WHEN C-2329/GRA-39 OR C-2329A/GRA 39 HAS MWD 11-5820-477-30 APPLIED
- 3 THE REMOTE CONTROL IS LOCATED NEXT TO SB-22/PT TO ENABLE SWITCHBOARD OPERATOR TO HEAR INCOMING RADIO CALLS

EL 5820 798 2-03 TM 5

Figure 6-4. AN/GRA-39(*) in RWI with receiver-transmitter,

6-13. Retransmission Cable Kit MK456/ GRC

a. The MK-456/GRC consists of a canvas bag (Bag, Cotton Duck CW-502/PRC) and a 50-foot cable assembly CX-4656/GRC which has two network boxes, one of which is provided with a receptacle for connecting an audio accessory to monitor the retransmission passing through the relay system. Cable connectors at the ends of the cable assembly provide for connection to receiver-transmitters. The MK-456/GRC provides for retransmission at a relay site for other radio stations that are too far distant to communicate directly.

b. The MK-456/GRC provides retransmission between the receiver-transmitters of the AN/PRC-25, AN/PRC-77, AN/VRC-53, and the AN/VRC-64, between the receiver-transmitters of these radio sets and Receiver-Transmitter, Radio RT-246/VRC or RT-524/WVRC of the AN/VRC-12 radio series, and between the receiver-transmitters of the AN/VRC-12 radio series. The radios that are set up in retransmission are separated by the full 50-foot length of the CX-4656/GRC and they must be operated in squelch-on mode.

c. The frequencies of the two relay radios are selected for noninterference. When the RT-505/PRC-25's (from the AN/PRC-25 and AN/VRC-53) are used, the frequency interference graph in the AN/PRC-25 publication, TM 11-5820-398-12, is used. When the RT-841/PRC-77's (from the AN/PRC-77 and AN/VRC-64) are used, the frequency interference graph in the AN/PRC-77 publication, TM 11-5820-667-12, is used. When the RT-246/VRC's and RT-524/VRC's are used, the frequency interference graph in the AN/VRC-12 publication, TM 11-5820-401-10, is used. When the RT-505/PRC-25 or RT-841/PRC-77 is used with the RT-246/VRC or RT-524/VRC at the retransmission site, it is recommended that the retransmission chart for the AN/VRC-12 series be used (TM 11-5820-401-10). In any configuration, if

any interfering frequencies are encountered, other than those indicated in the interference graphs, record these frequencies for future reference.

d. To provide for retransmission, proceed as follows. (Refer to figure 6-5 for connections and control setting details required for retransmission operation.)

- (1) Connect the CX-4656/GRC to the radio sets (radio sets 2 and 3, fig. 6-5) at the retransmission site. Separate the two radios the full length of the CX-4656/GRC.

Note. The full separation is required to reduce interference of radio signals with the audio signals in the cable assembly.

- (2) First, establish communication with each of the terminal radios (between radio sets 1 and 2, and 3 and 4) *without* squelch mode of operation.
- (3) When communication is satisfactory without squelch, arrange for squelch operation and check for satisfactory communication between the radio sets (1 and 2, and 3 and 4). (See para 3-12 for information on squelch and non-squelch operation.)
- (4) Advise the terminal radios (1 and 4) that the next communication will be between them. In the meanwhile, set the controls on the relay radios for retransmission (note 6, chart, fig. 6-5). Communication between the terminal radios (1 and 4) proceeds automatically.
- (5) The operator at the retransmission site can monitor (listen to) the communication occurring in both communication directions by connecting an audio accessory to the receptacle on the network box of the CX-4656/GRC. To talk to either distant station, the operator must connect his audio accessory to the relay radio audio receptacle.

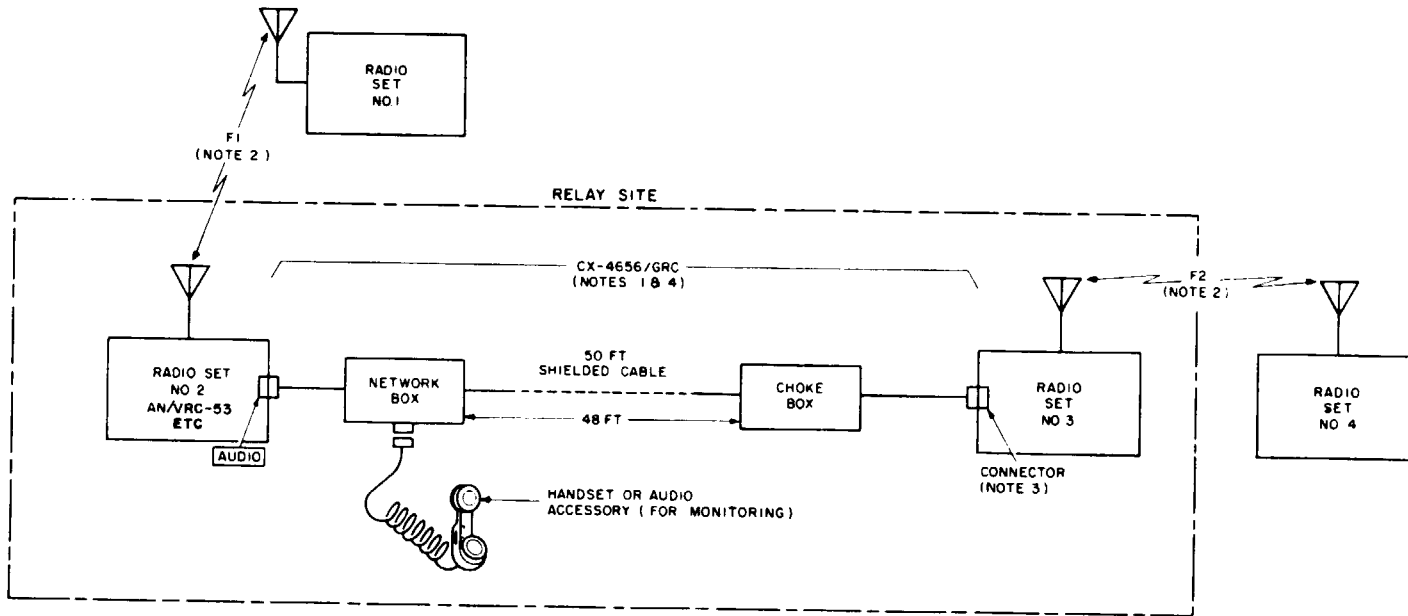

- 1 PART OF MK-456/GRC.
- 2 FREQUENCIES FOR F1 AND F2 ARE SELECTED FOR NON-INTERFERENCE
- 3 WHEN RT-505/PRC-25 OR RT-841/PRC-77 IS USED, CONNECT CABLE TO **AUDIO** CONNECTOR. WHEN RT-246/VRC OR RT-524/VRC IS USED, CONNECT CABLE TO **RETRANSMIT R/W** CONNECTOR
- 4 RADIO SETS NO 2 AND NO 3 AT RELAY SITE SEPARATED BY FULL LENGTH (50 FT) OF CX-4656/GRC.
- 5 INDICATES EQUIPMENT MARKING.
- 6 SWITCH POSITIONS REQUIRED FOR VARIOUS RADIOS IN THE RADIO RELAY NET, AS SHOWN IN TABLE

NOTES:

TERMINAL RADIO		RADIO RELAY SITE				TERMINAL RADIO	
RADIO SET NO 1		RADIO SET NO 2		RADIO SET NO 3		RADIO SET NO 4	
RADIO	SWITCH	RADIO	SWITCH	RADIO	SWITCH	RADIO	SWITCH
RT-505/ PRC-25 OR RT-841/ PRC-77	FUNCTION SQUELCH	RT-505/ PRC-25 OR RT-841/ PRC-77	FUNCTION RETRANS	RT-505/PRC-25 OR RT-841/PRC-77	FUNCTION: RETRANS	RT-505/ PRC-25 OR RT-841/ PRC-77	FUNCTION SQUELCH
RT-246/VRC OR RT-524/VRC	SQUELCH: NEW ON, NEW OFF, OR OLD OFF			RT-246/VRC OR RT-524/VRC	SQUELCH: NEW ON	RT-246/VRC OR RT-524/VRC	SQUELCH: NEW ON, NEW OFF OR OLD OFF
AN/ARC-54 OR AN/ARC-131	SQUELCH: TONE			RT-246/VRC OR RT-524/VRC	SQUELCH OLD ON	AN/ARC-54 OR AN/ARC-131	SQUELCH: TONE
						COMPATIBLE FM RADIO SET OTHER THAN THOSE LISTED ABOVE	NOT APPLICABLE

TM5820-498-12-C1-30

Figure 6-5. Setup for radio relay retransmission and required control settings.

6-14. Power Supplies PP-2953/U and PP-6224/U and Variable Power Transformer TF-523/U

a. Power Supply PP-2953/U and models A, B, and C (TM 11-6130433-12) can be used to provide regulated 24 volts dc from an ac power source for up to two vehicular radios (AN/VRC-53 and/or AN/VRC-64). (It is also used to power one receiver-transmitter of the AN/VRC-12 series radios (TM 11-5820-401-12)).

(1) Ac power sources may be 115 volts, 50-60 cps (4 amperes maximum); 230 volts, 50-60 cps (2 amperes, maximum); and 115 volts, 400 cps (4 amperes, maximum).

(2) The regulated 24-volt dc output (10 or 12 amperes, maximum (depending on the model of the PP-2953/U)) is applied through Cable Assembly, Power, Electrical CX-1721/VRC and the MT-1029/VRC to the amplifier power supply from which it is applied to the receiver-transmitter.

b. Power Supply PP-224/U (TM 1145130466-15) is similar to the PP-2953/U (a above) except that it can supply up to 25 amperes.

c. Variable Power Transformer TF-523/U (also identified as Variable Power Transformer Model W20HMT3A) (TM 11-5950-212-15) is used to supply a constant 115 volts ac from commercial power sources that produce a variety of line voltages (90 to 240 volts ac; 50 to 400 CPS). The variable transformer can be adjusted to provide a constant voltage between 0 and 280 volts ac. It may be used to apply the constant 115-volts ac to the PP-2953/U (a above) or PP-6224/U (b above) when the ac power source is below or above the operating range of these power supplies.

6-15. Antenna Equipment RC-292

The RC-292 is a ground plane whip antenna that will increase the communication range of the radio sets. It consists of a 30-foot mast; a 68-foot, 50-ohm leadin cable, and antenna sections to provide a 30° ground plane and upright whip section. The length of the ground plane and the upright antenna section depend on the operating frequency of the radio. Refer to TM 11-5820-348-15 for installation instructions. When the antenna is used with the radio set, neither the MX-2799/VRC of the AT-912/VRC nor the MX-3707/VRC of the AS-1729/VRC is used.

6-16. Antenna AT-984A/G

a. The AT-984A/G is a 150-foot length of copper wire wound on a small fishing-type reel with a bag to store the reel. It increases the communication range of the radio sets. Refer to TM 11-58203-98-12 (AN/PRC-25) or TM 11-5820-667-12 (AN/PRC-77) for citing information and maintenance of the AT-984A/G.

WARNING

If the tactical situation permits, use warning signs or similar safety measure to prevent persons or vehicles from running into the antenna wire when it is stretched out above the ground.

b. To connect the antenna to the receiver-transmitter, remove the long whip Antenna AT-271A/PRC from Support, Antenna AB-591/PRC-25 (fig. 1-13). Unscrew the AB-591/PRC-25 slightly and insert the terminal lug on the end of the antenna wire under it, and tighten the AB-591/PRC-25. Tie the cord attached to the antenna wire to a nearby support that is capable of supporting the wire when it is stretched to another support 150 feet away. Unreel the antenna wire by moving *in the direction of the other radio station* (transmission and reception is off the end of the long wire antenna in the direction of the other radio set). Stretch the antenna wire approximately 4 feet above the ground by securing the reel (which is provided with a tie cord for this purpose) to a building, tree, post or similar support.

6-17. Antenna, Loop AT-784/PRC

The AT-784/PRC is a small handheld homing antenna that is used in conjunction with radio sets in the 30- to 76-mc band. Manipulated in conjunction with the receiver transmitter, it enables a radio operator to determine the direction from which a radio signal is being transmitted. The transmitted signal can be a marker device that sends out an fm signal on a certain frequency or it can be another radio. Refer to TM 11-5985-284-15 for instructions on the use of the AT-784/PRC.

6-18. Loudspeaker, Electromagnetic LS-549/PRC

This item is no longer available.

Figure 6-6. **DELETED.**

6-19. Radio Set Control AN/GSA-7 and Oscillator O-574/GRA

a. General.

(1) Oscillator O-574/GRA (figs. 6-7 and 6-8) produces a 1,600-cps ringing signal for transmission through a radio system. The O-574/GRA is provided with two cables assemblies: Cable Assembly (SC-C-75348) and Cable Assembly, Special Purpose, Electrical CX-10177/U. Cable Assembly (SC-C-75348) is provided for connection between the O-574/GRA and an audio accessory such as Handset H-33/PT; the CX-10177/U is provided for connection between the O-574GRA and the radio

set and an audio accessory, such as H-189/G or combat vehicle crewman (CVC) helmet.

NOTE

The O-574/GRA may be used with other radio sets such as the AN/VRC-12 series (C, fig. 6-11), the AN/PRC-77, and PRC-25, and AN/GRC-3 through AN/GRC-8. The O-574/GRC is provided to radio sets in a RWI network to enable the radio operator to ring into a switchboard which is connected to another radio set through Radio Set Control AN/GSA-7 ((2) below).

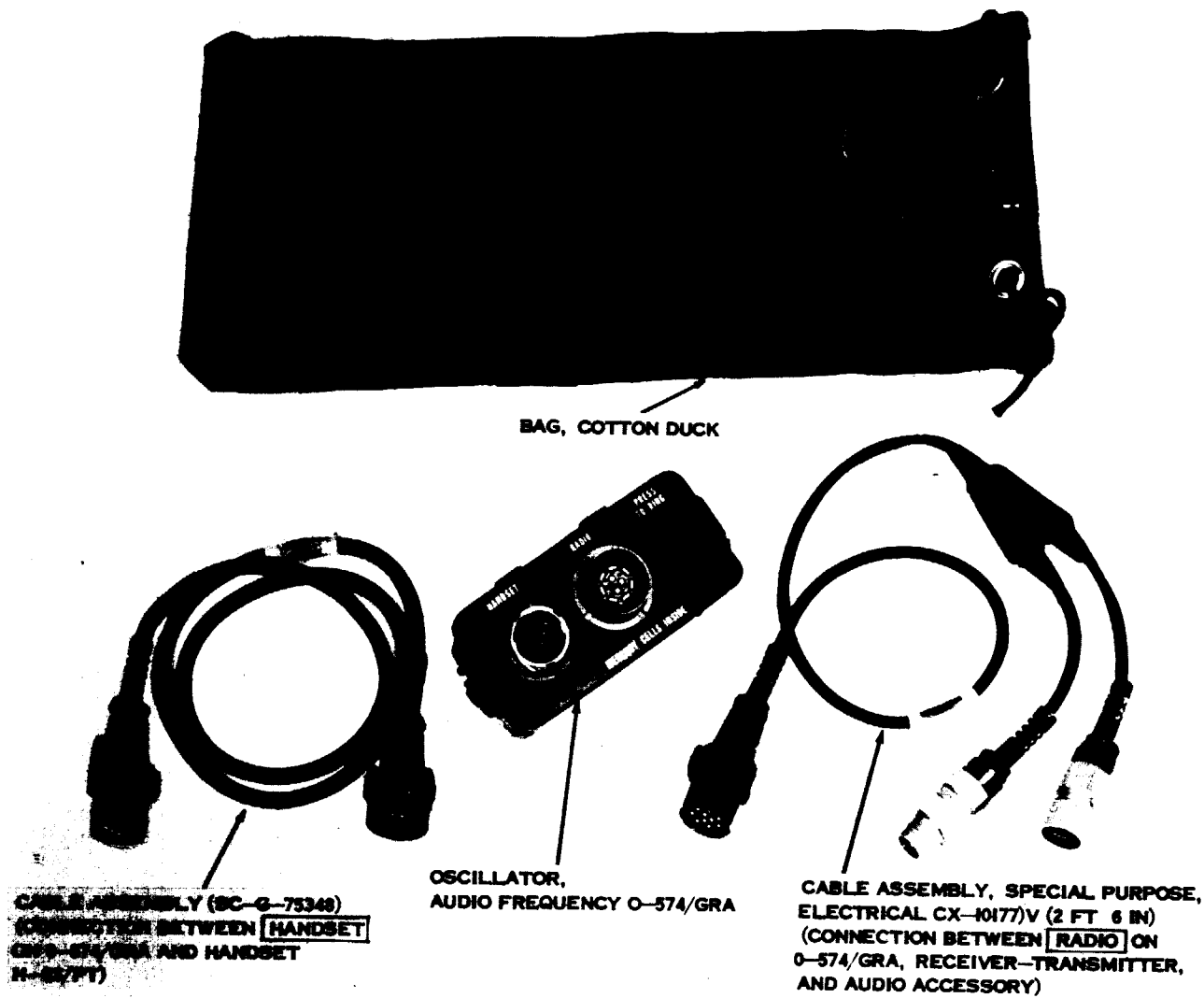

A. OSCILLATOR, AUDIO FREQUENCY 0-574/GRC.

TM5820-498-12-CI-23

Figure 6-7. Oscillator O-574/GRA.

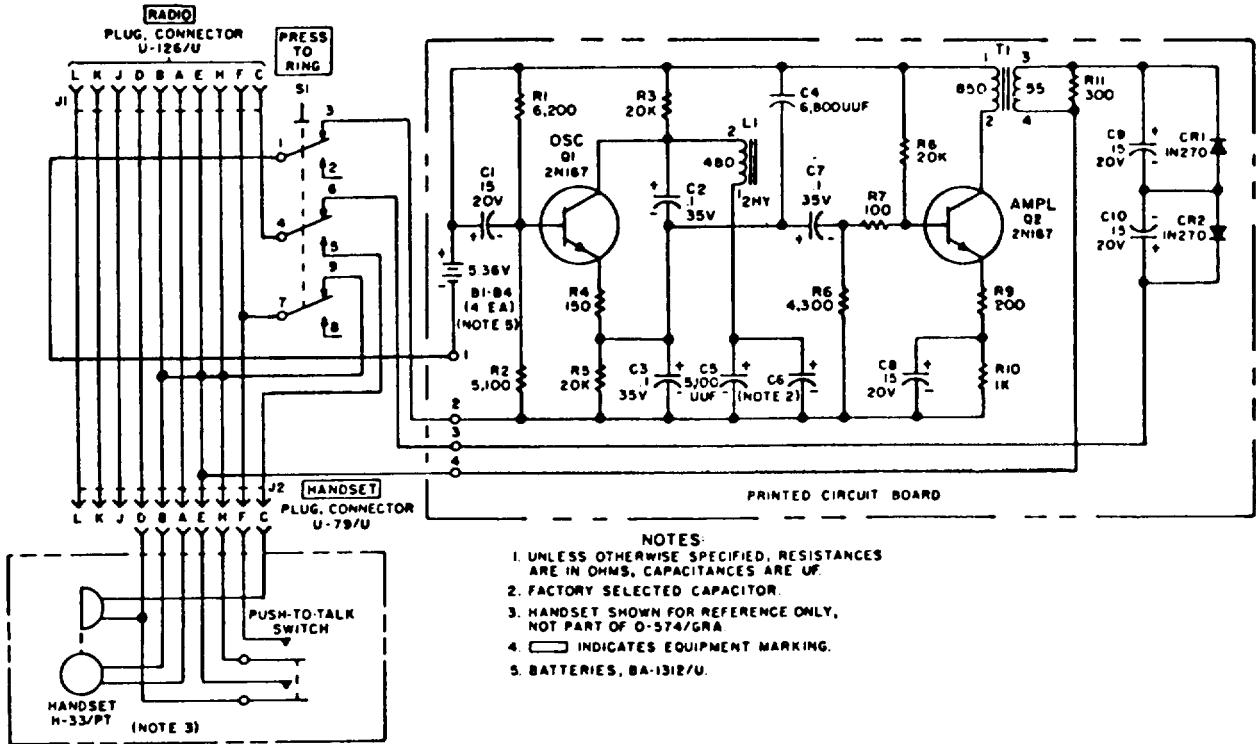

A. OSCILLATOR, AUDIO O-574/GRA WITH HANDSET H-33/PT.

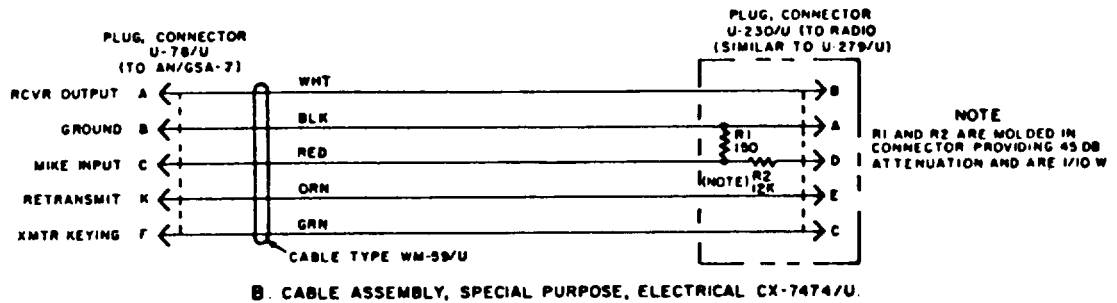

B. CABLE ASSEMBLY, SPECIAL PURPOSE, ELECTRICAL CX-7474/U.

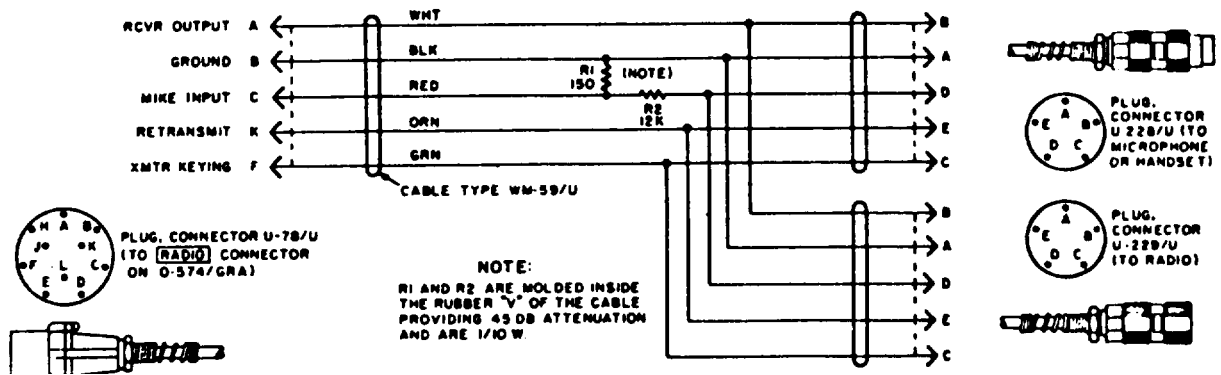

C. CABLE ASSEMBLY SPECIAL PURPOSE ELECTRICAL CX10177/U 12 FT, 6 IN).

EL5820-489-12-C8-TN-2

Figure 6-8. oscillator O-574/GRA and Cable Assemblies, Special Purpose, Electrical CX-7474/U and CX-10177/U, schematic diagram.

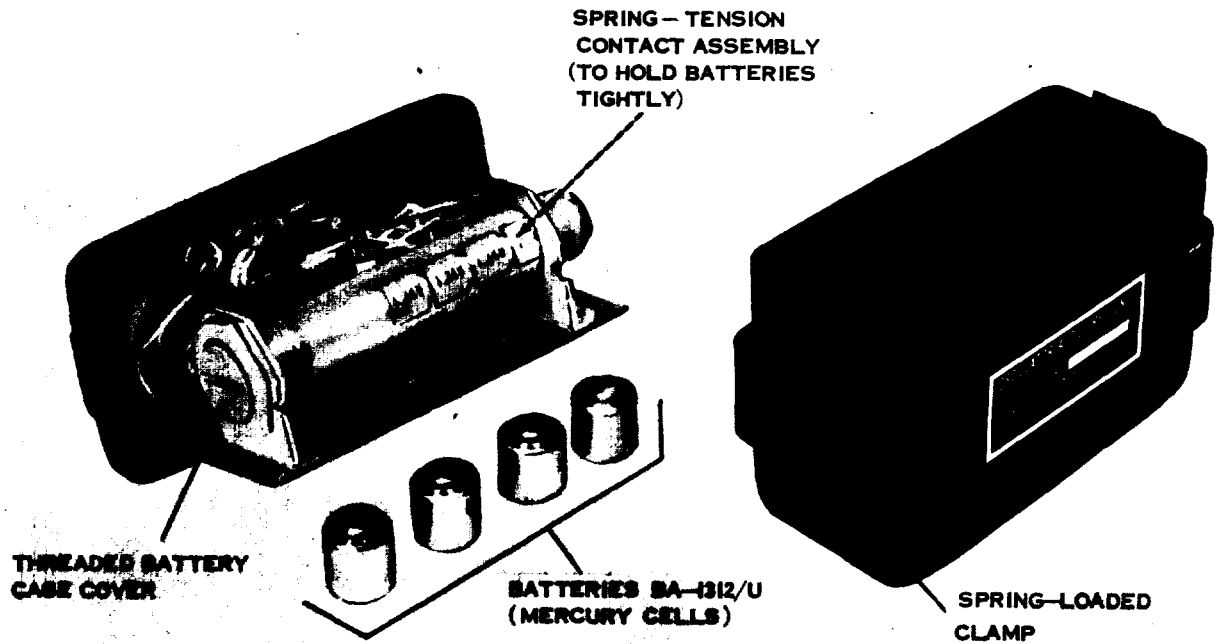

B. OSCILLATOR, AUDIO FREQUENCY 0-574/GRA WITH BATTERIES.
(LESS CABLES AND BAG)

TM 5820-498-12-C1-24

B. OSCILLATOR, AUDIO FREQUENCY 0-574/GRA WITH BATTERIES.
(LESS CABLES AND BAG)

TM5820-498-12-C1-24

Figure 6-9. Oscillator O-574/GRA with Batteries BA-1312/U.

(2) Radio Set Control AN/GSA-7 (TM 11-5135-15) is used to provide RWI between Switchboard, Telephone SB-22/PT (TM 11-5805-262-12) and a radio set that is located up to approximately 10 miles (16 km approx) distant from the radio set. With the AN/GSA-7, there are four methods of pro-

viding RWI, depending on the number of AN/GSA-7's in the system (fig. 6-11). Cable Assembly, Special Purpose, Electrical CX-7474/U (fig. 6-10) is required for connection between the receiver-transmitter of the radio set and the AN/GSA-7.

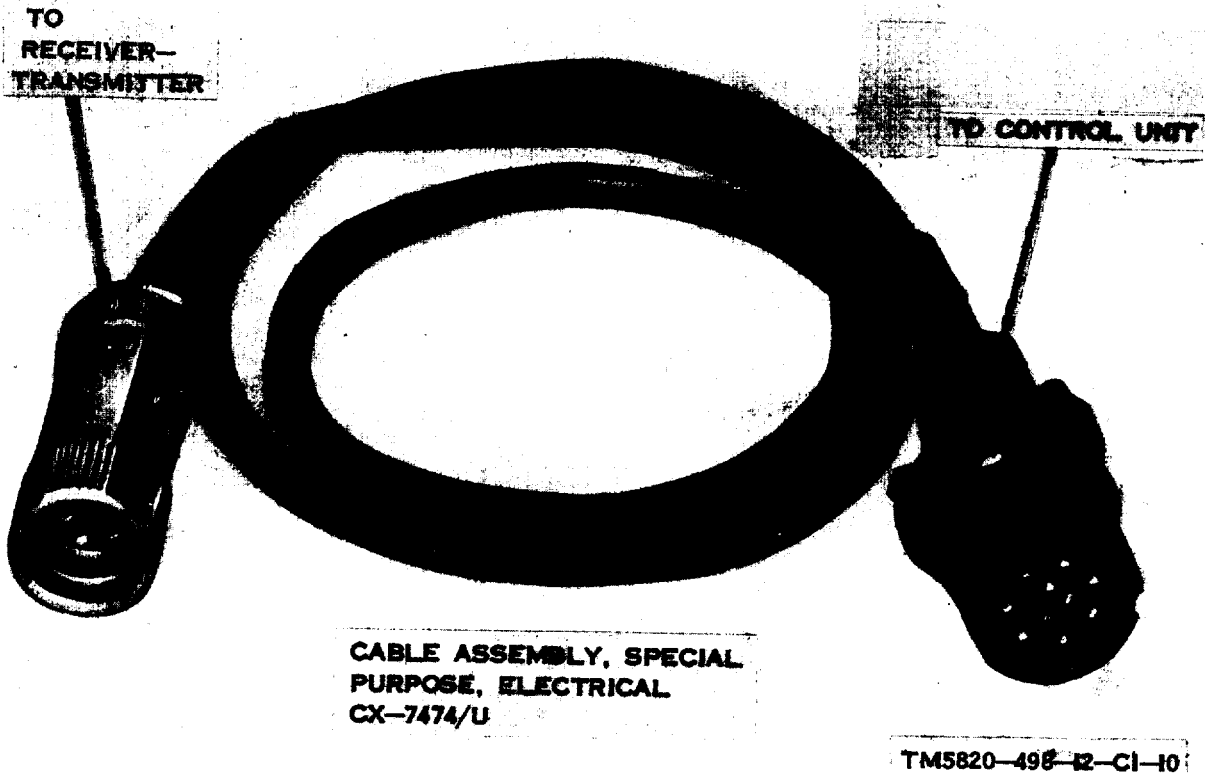
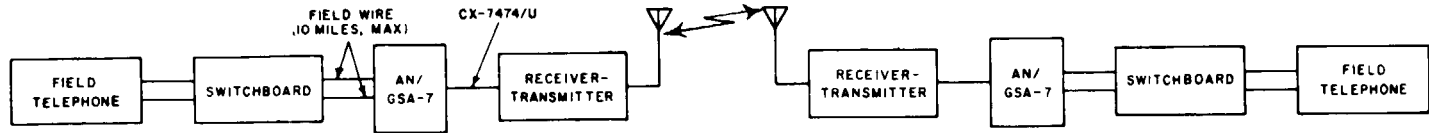

Figure 6-10. Cable Assembly, Special Purpose, Electrical CX-7474/U.

(a) When there is a AN/GSA-7 at the other radio station (A, fig. 6-11) or the other radio station has an O-574/GRA (C, fig. 6-11) the AN/GSA-7 ringing feature (converting the switchboard 20-cps ringing signal to 1,600-cps signal for transmission through the radio system and vice versa) can be used. Therefore, a radio operator at each AN/GSA-7 is not required as indicated in *b* below. The operating procedures used when there are two AN/GSA-7'S in the system are given in *c* below. The operating procedures when there is an AN/GSA-7 and an O-

574/GRA in the system are given in *d* below.

(b) When there is no AN/GSA-7 at the one radio station (B, D, fig. 6-11), the automatic ringing feature in the AN/GSA-7 through the radio system is no longer effective. Either an operator is located at the AN/GSA-7 who arranges with the switchboard operator for RWI (B, fig. 6-11, and *d(1)* Mow) ; or a telephone located next to, and connected to the radio through the switchboard, is used by the switchboard operator to hear radio calls (D, fig. 6-11) .



A. AN/GSA-7 AT BOTH STATIONS; RADIO OPERATOR NOT REQUIRED.

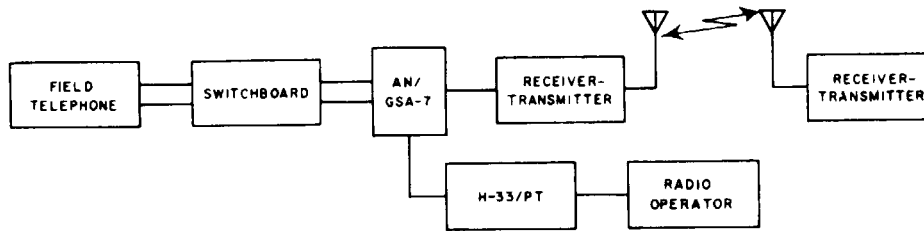

B. AN/GSA-7 AT ONE STATION; RADIO OPERATOR REQUIRED.

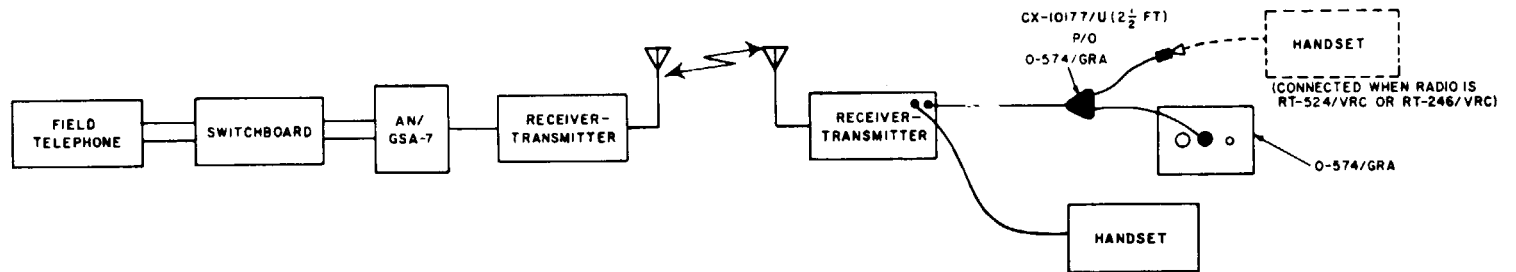

C. AN/GSA-7 AT ONE STATION, O-574/GRA AT OTHER; NO RADIO OPERATOR REQUIRED.

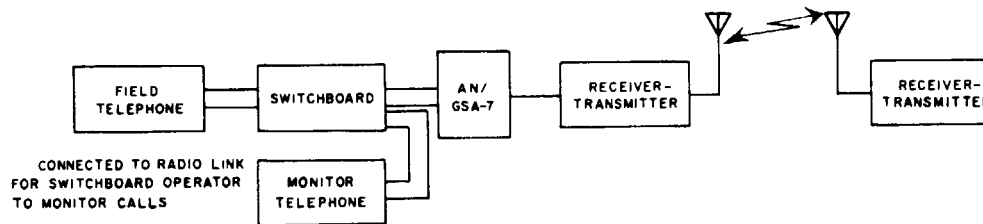

D. AN/GSA-7 AT ONE STATION, RADIO MONITOR TELEPHONE; NO RADIO OPERATOR REQUIRED.

Figure 6-11. Arrangements for RWI with receiver-transmitter and Radio Set Control AN/GSA-7.

b. Connections. The following connections at the AN/GSA-7 are used whether there is a radio operator in the system (*c* below) or there is not (*d* below).

- (1) Install four Batteries, Dry BA-1312/U (fig. 6-9) in the O-574/GRA. Unlatch the spring-loaded clamps, and remove the front panel with the chassis attached. Install the four BA-1312/U batteries as shown on the diagram on the tubular battery case. The spring-loaded contact assembly in the bottom of the battery case will cause the top battery to protrude slightly. Screw on the threaded battery case cover completely. Replace the chassis in the case and tighten the spring-loaded clamps.
 - (2) Interconnect the AN/GSA-7 and receiver-transmitter with the CX-7474/U (A, fig. 6-12). Do not connect the monitor telephone unless there is no radio operator at the AN/GSA-7 (*d* (2) below).
 - (3) Set the receiver-transmitter function switch to ON. Tune in a desired radio station.
 - (4) Make the following adjustments on the AN/GSA-7:
 - (a) Connect the AN/GSA-7 to a power source (TM 11-5135-15).
 - (b) Set the OFF-AC-DC switch to AC or DC, depending on the power source.
- (c) Connect the H-33/PT to the AUDIO connector.
 - (d) Set the monitor switch to T RADIO&MON. The rushing noise from the receiver-transmitter should be heard.
 - (e) Connect the field wires from the switchboard to the AN/GSA-7 LINE binding posts. If the rushing noise ceases, and beeps originating in the AN/GSA-7 are heard (indicating the receiver-transmitter has been keyed), transpose the field wires at the LINE binding posts. The rushing noise should return and the beeps from the AN/GSA-7 should cease. If this does not occur, make the following checks:
 - (1). Check to see that no switchboard cord is connected to the radio link jack (B, C, fig. 6-12).
 2. Be sure that the field wires are not shorted.
 - (f) Proceed to check the operation of the radio with the H-33/PT.
 - (g) Use the procedures given in *c* below when there are two AN/GSA-7's in the system, and refer to the procedures given in *d* below when there is no other AN/GSA-7 in the system.

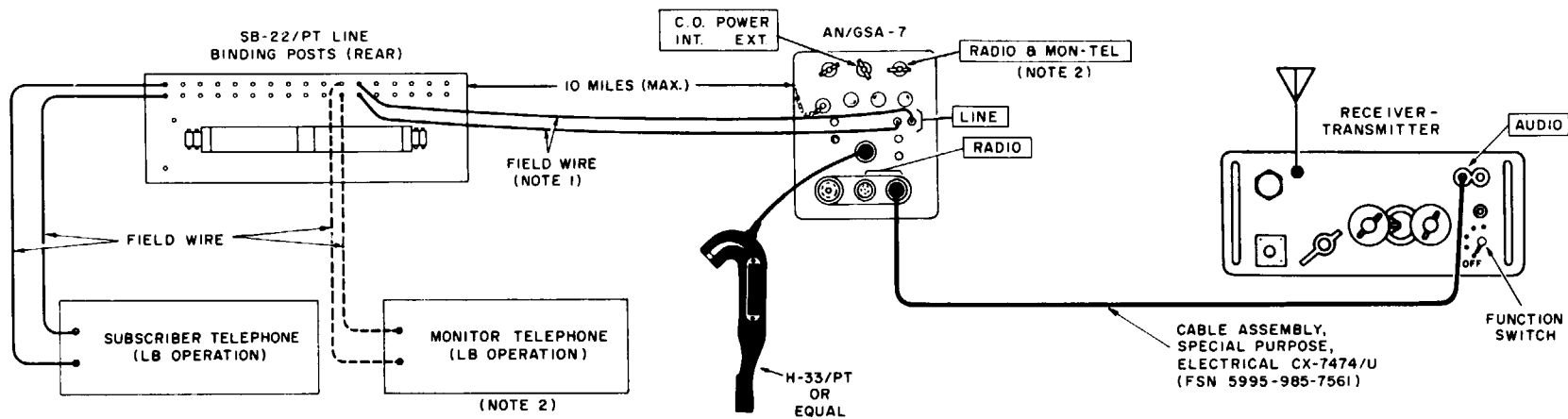

A. CONNECTIONS AND SWITCH POSITIONS.

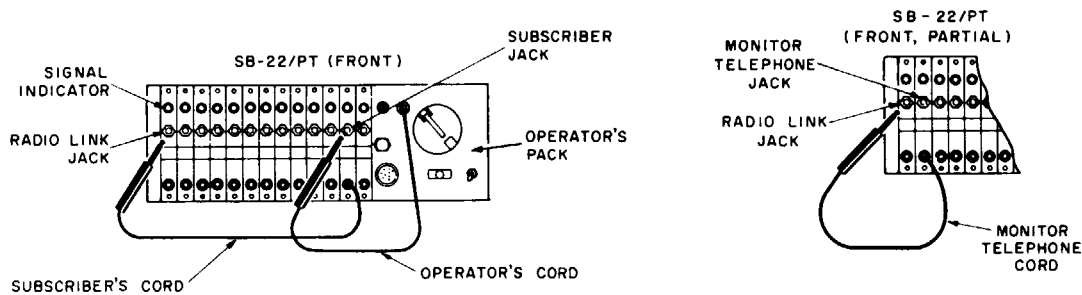

B. CORD CONNECTIONS FOR OPERATOR AND SUBSCRIBER COMMUNICATION ON RADIO LINK.

C. CORD CONNECTION FOR MONITOR TELEPHONE (NOTE 2).

NOTES:

1. IF RECEIVER-TRANSMITTER IS KEYED, TRANSPOSE THESE CONNECTIONS AT SB-22/PT.
2. THE MONITOR TELEPHONE IS LOCATED AT SB-22/PT TO ENABLE SWITCHBOARD OPERATOR TO HEAR INCOMING RADIO CALLS ON THE HANDSET WHEN THERE IS NO OPERATOR AT THE AN/GSA-7.

Figure 6-12. Radio Set Control AN/GSA-7 with receiver-transmitter to provide RWI; connections and control settings.

Change 2

6-17

TM5820-398-12-C2-12

TM 11-5820-498-12

c. Two AN/GSA-7's in System. When there is an AN/GSA-7 at each radio station, no radio operator is required at the AN/GSA-7 connected to the receiver-transmitter (A, fig. 6-11). Normal 20-cps switchboard ringing between switchboard operators over the radio system can be used.

- (1) Interconnect the AN/GSA-7 and radio equipment (*b* above).
- (2) On each AN/GSA-7, set the monitor switch to T RADIO&MON position.
- (3) Set the switch on the subscriber's telephone to LB operation.
- (4) Switchboard and subscriber telephone operation proceed normally for radio operation. Use the hand generator (20 cps) to call the distant switchboard; use push-to-talk radio operation with the proper radio call signs and radio procedures.

d. One AN/GSA-7 in System. When there is no AN/GSA-7 at the other radio station, there are three methods of providing RWI. In one arrangement ((1) below), a radio operator is stationed at the AN/GSA-7 to make the RWI arrangements with the switchboard operator (B, fig. 6-11). In a second arrangement ((2) below), a telephone at the switchboard is continuously connected to the radio system; therefore the switchboard operator answers radio calls and makes RWI connections ((2) below), becoming a radio operator for the operation (D, fig. 6-11). For a third arrangement ((3) below), the distant radio station operator is provided with Oscillator O-574/GRA, which will provide the 1,600-cps signal to ring through an unattended AN/GSA-7 to call the switchboard (C, fig. 6-11).

- (1) *Radio operator at AN/GSA-7.* These procedures require a radio operator at the AN/GSA-7.
 - (a) Interconnect the AN/GSA-7 equipment (*b* above).
 - (b) At the AN/GSA-7, set the monitor switch to T RADIO&MON position. Use the H-33/PT to communicate with the distant radio station.
 - (c) When RWI is required for communication with a switchboard sub-

scriber, advise the distant radio station to standby while the arrangements in -1, 2, and 3, below are being made:

1. On the AN/GSA-7, hold the monitor switch to R TEL to ring the switchboard. Release the switch and request the switchboard operator for the desired subscriber.
 2. At the switchboard, the operator connects the operator's cord to the desired subscriber's jack, rings, and advises the subscriber of the radio call, the call signs, and requests him to ring back when the radio communication is completed.
 9. The switchboard operator then connects the subscriber's cord to the radio link jack (B, fig. 6-22), and tells the radio operator that the subscriber is ready.
- (d) At the AN/GSA-7, the radio operator sets the AN/GSA-7 monitor switch to T RADIO&MON position. Communication between the subscriber and the distant radio station proceeds automatically on push-to-talk radio operation. The radio operator at the AN/GSA-7 can monitor the communication.
- (e) At the switchboard, the operator removes the operator's cord from the subscriber's jack during the subscriber radio communication.
- (f) When the subscriber rings off (the subscriber's signal indicator will indicate white), insert the operator's cord into the subscriber's jack and challenge the circuit, without operating the headset-chestset switch to push-to-talk *radio* position (this would key the radio).
- (g) Remove the operator's and subscriber's cords when the subscriber radio communication is finished
- (2) *No radio operator at AN/GSA-7*
When there is no radio operator available at the AN/GSA-7, a monitor tele-

phone is connected at the switchboard to the radio link and will be used to listen for radio calls that require RWI connections.

- (a) Interconnect the AN/GSA-7 equipment (*b* above).
- (b) Connect a monitor telephone to the switchboard (A, fig. 6-12) ; set it for LB operation and locate the telephone handset so that the switchboard operator can hear radio calls. Connect the monitor telephone cord to the radio link jack (C, fig. 1-12).
- (c) To communicate with the distant radio station, insert the operator's cord into the monitor telephone jack (C, fig. 6-12). Operate the handset-chestset switch to push-to-talk radio position to key the radio and communicate with the distant radio station; use proper call signs and radio procedure.
- (d) When a radio call is heard on the monitor telephone handset, use the monitor telephone to answer the call. When the desired subscriber has been determined, advise the distant radio station to standby while the arrangements in 1 and 2 below are being made.
 1. Insert the operator's cord into the subscriber's jack, ring, and advise the subscriber of the radio call, and the call signs; request him to ring back when the radio communication is finished.
 2. Remove the monitor telephone cord from, and connect the subscriber's cord to the radio link jack. Communication between the subscriber and distant radio station proceeds automatically with push-to-talk radio operation.
- (e) Remove the operator's cord from the subscriber's jack.
- (f) When the subscriber rings off (the subscriber's signal indicator will

show white), insert the operator's cord into the subscriber's jack, and challenge the circuit without operating the headset-chestset switch to the push-to-talk *radio* position (this would key the radio).

- (g) Remove the operator's cord from the subscriber's jack and reconnect the monitor telephone cord to the radio link jack (C, fig. 6-12) to await further radio calls.
- (3) O-574/GRA *provided at radio*. When one *radio* is connected to the AN/GSA-7 and another radio is provided with the O-574/GRA (C, fig. 6-11), operation can proceed as though there were two AN/GSA-7's in the system.
- (a) Interconnect the AN/GSA-7 equipment (*b* above).
 - (b) Connect the O-574/GRA to the receiver-transmitter (C, fig. 6-11).
 - (c) When the radio operator with the O-574/GRA desires to call the switchboard, he presses the RING switch on the O-574/GRA for a few seconds. The switchboard operator answers and makes the necessary connection to the subscriber.
 - (d) When the switchboard operator desires to call a radio operator provided with an O-574 /GRA, he can either use 20-cps ringing or use the call sign on the radio link line. If the switchboard operator uses his 20-cps ringing for calling the O-574/GRA user, the user must be aware of the 1,600-cps buzz in his audio accessory, alerting him to a call from the switchboard operator.

6-20. Radio Set Control AN/GRA-6

The AN/GRA-6 (TM 11-5038) may be used to provide remote radio control of the radio transmission and reception of the radio set at a separation of 2 miles (1.6 km approx) (*a* below). This equipment may also be used to provide RWI between Switchboard, Telephone

SB-22/PT (TM 11-5805-262-12) and the radio set (*b* below). Cable Assembly, Special Purpose, Electrical CX-7474/U (fig. 6-10) (FSN 5995-985-7561) (para 6-19a(1)) is required for the connection between the receiver-transmitter and the Local Control C-434/GRC (A, fig. 6-13). Remote Control C-433/GRC is connected to the C-434/GRC with field wire.

a. Remote Radio Control.

(1) *Connections.*

- (a) Install the batteries in the local and remote control units of the AN/GRA-6 (TM 11-5038).
- (b) Locate the local control unit next to the receiver-transmitter and interconnect the two units with the CX-7474/U (fig. 6-10, and A, 6-13).
- (c) Connect a handset to the receiver-transmitter; it will be used by the radio operator for radio communication.
- (d) Interconnect the local and remote control units with field wire.
- (e) To check for proper connection of the field wire to the units, perform the following operations:
 1. Turn on the receiver-transmitter by setting the function switch to ON. A rushing noise should be heard on the handset.
 2. At the local control unit, set the REMOTE switch to SET 1.
 3. At the remote control unit, set the SELECTOR switch fully counterclockwise (for the left-hand write-in position). Operate the H-33/PT push-to-talk switch and observe that the receiver-transmitter has been keyed. If it is not, release the push-to-talk switch and reverse the field wire connection to the LINE binding posts of either control unit, Recheck the keying of the receiver-transmitter.

Warning: Voltages as high as 45 volts dc are present on the

field wire when the radio is keyed from the remote control unit.

- (2) *Telephone operation between control units.* To prevent accidental keying of the radio by the remote control unit handset, always set the REMOTE switch on the local control unit to TEL ONLY.

(a) To ring from either the local or remote control unit, crank the handle of the ringing generator.

(b) To communicate between the two control units, proceed as follows:

1. At the local control unit, set the LOCAL switch to TEL; at the remote control unit, set the SELECTOR switch to TEL.
2. Remove the CX-7474/U from the local control unit AUDIO connector and replace it with an H-33/PT (or equal).
3. Communicate between the two control units using the associated handsets.

- (3) *Radio communication.* Check to see that the CX-7474/U is connected between the local control unit and the receiver-transmitter (A, fig. 6-13).

(a) To communicate on the radio at the local control unit, use the handset connected to the receiver-transmitter.

(b) To communicate on the radio from the remote control unit, proceed as follows:

1. At the local control unit, set the REMOTE switch to SET 1.
2. At the remote control unit, set the SELECTOR switch fully counterclockwise ((1) (e)3 above).
3. Operate the H-33/PT at the remote control unit to communicate on the radio using push-to-talk radio operation with the proper call signs and radio procedure.

b. RWI Operation.

- (1) *Connections.*

- (a) Install batteries in the local and remote control units (TM 11-5038).
 - (b) Locate the local control unit next to the receiver-transmitter and interconnect the two units with the CX-7474/U (B, fig. 6-13).
 - (c) Locate the remote control unit next to the switchboard, and interconnect the local and remote control units and the switchboard with field wire.
 - (d) Locate a monitor telephone next to the switchboard and connect it to one of the line binding posts of the switchboard.
 - (e) To check for proper connection of the field wire between the local and remote control units, perform the following operations:
 1. Turn on the receiver-transmitter by setting the function switch to ON. Connect a handset to the receiver-transmitter; the rushing noise from the radio should be heard.
 2. At the local control unit, set the REMOTE switch to SET 1.
 3. At the remote control unit, set the SELECTOR switch fully counterclockwise (for the left-hand write-in position).
 4. At the remote control unit, connect a H-33/PT to the AUDIO connector (B, fig. 6-13) ; tape the handset push-to-talk switch so that it is always operated.
 5. At the switchboard, connect the operator's cord to the radio link jack, and operate the switch on the operator's headset-chestset to the push-to-talk radio position to key the radio. If the radio is not keyed, release the switch and reverse the connections of the field wire to the switchboard binding posts. Recheck the keying of the radio with the switchboard operator's set.
 - (f) Connect the monitor telephone cord to the radio link jack (D, fig. 6-13) ; set the telephone for LB operation and locate the telephone handset so that the switchboard operator can hear radio calls.
- (2) *Operation.* The monitor telephone connected at the switchboard to the radio link will be used by the operator to hear incoming radio calls requiring RWI.
- (a) To communicate on the radio from the receiver-transmitter, use the handset connected to the radio.
 - (b) To use the telephone circuit between the local and remote control units, connect a H-33/PT to the local control unit in place of the CX-7474/U and use the procedures given in *a* (2) above.
 - (c) For the switchboard operator to communicate on the radio, proceed as follows:
 1. Connect the operator's cord to the radio link jack.
 2. Use the push-to-talk *radio* position of the headset-chestset switch to key the radio and release the switch to receive the radio communication.
 - (d) When a radio call is heard on the monitor telephone, insert the operator's cord into the monitor telephone jack. When the desired subscriber has been determined, advise the distant station to standby while the arrangements in *1* and *2* below are being made:
 1. Insert the operator's cord into the subscriber's jack, ring, and advise the subscriber of the radio call and call signs; request him to ring back when the radio communication is completed.
 2. Remove the monitor telephone cord from the radio link jack (D, fig. 6-13) and connect the subscriber's cord to the radio line jack

(C, fig. 6-13). Communication between the subscriber and distant station proceeds automatically with push-to-talk radio operation.

- (e) Remove the operator's cord from the subscriber's jack.
- (f) When the subscriber rings off (the subscriber's signal indicator will show white), insert the operator's cord into the subscriber's jack, and

challenge the circuit without operating the headset-chestset switch to the push-to-talk *radio* position (this would key the radio).

- (g) Remove the operator's cord from the subscriber's jack and reconnect the monitor telephone cord to the radio link jack (D, fig. 6-13) to await further radio calls.

Section IV. CABLES USED WITH RADIO SETS AND INTERCOM

Note. The lengths of the cables listed in paragraphs 6-21 through 6-31 vary depending on the vehicle or weapons vehicle requirement. Refer to SB 11-131 for details on lengths and Federal stocks numbers, and authorized cables that may be used with the AN/ VRC-53, AN/ VRC-64, AN/ GRC-125, and AN/G RC-160 for each vehicle radio and intercom system. Refer to figure 2-3 for the location of the various cables used in the radio and intercom system.

6-21. Cable Assembly, Special Purpose, Electrical CX-4722/VRC

The CX-4722/VRC is described in paragraph 1-13 and illustrated in figures 1-12 and 6-14.

6-22. Cable Assembly, Special Purpose, Electrical CX-4723/VRC

The CX-4723,VRC is used to connect MT-1029, VRC'S and system control boxes. It has an 18-terminal male connector at each end.

6-23. Cable Assembly, Special Purpose, Electrical CX-7055/VRC

The CX-7055/VRC is used to connect a C-2297/VRC to a vehicle connector in certain weapons vehicles. It has a 14-terminal female connector at one end and a 9-terminal male connector at the other.

6-24. Cable Assembly, Special Purpose, Electrical CX-7056/VRC

The CX-7056JVRC is used to connect a C-2296/VRC to a vehicle connector in certain weapons vehicles. It has a 9-terminal male connector at one end and a 14-terminal male connector at the other.

6-25. Cable Assembly, Special Purpose, Electrical CX-7057/VRC

The CX-7057/VRC is used to connect a C-

2297/VRC to a vehicle connector in certain weapons vehicles. It has a 14-terminal female connector on one end and a 9-terminal male connector on the other.

6-26. Cable Assembly, Special Purpose, Electrical CX-7060/VRC

The CX-7060/VRC is used to connect a C-2297/VRC or an AM-1780/VRC to a vehicle connector in certain vehicles. It has an 18-terminal male connector at one end and a 14-terminal male connector at the other.

6-27. Cable Assembly, Special Purpose, Electrical CX-7328/VRC

The CX-7328/VRC is used to connect a C-2298/VRC to a vehicle connector in certain weapons vehicles and vehicles. It has an 18-terminal male connector at one end and a 10-terminal connector at the other.

6-28. Cable Assembly, Special Purpose, Electrical CX-7555/VRC

The CX-7555/VRC is used to connect a C-2298/VRC to a vehicle connector in certain weapons vehicles and vehicles. It has an 18-terminal male connector at one end and a 10-terminal connector at the other.

Figure 6-13. AN/GRA-6 and receiver-transmitter, remote radio control and RWI; connections and control settings.
(Located in back of manual.)

WARNING

POTENTIAL AS HIGH AS 45 VDC EXIST ON THESE WIRES WHEN THE RADIO IS KEYS, AND AS HIGH AS 60 VAC WHEN TELEPHONE RINGING IS USED

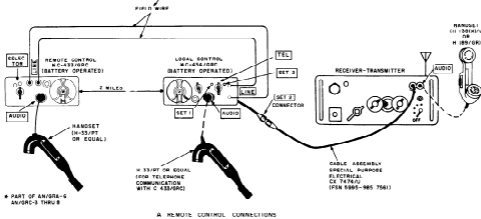

* PART OF AN/GR-6 AN/GR-3 THRU 8

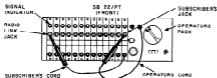
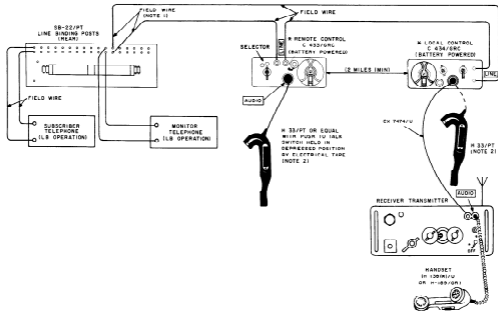

NOTES

1. IS BY 606/JRC-38 IS KEYS TRANSFER CONNECTION OF THESE WIRING AT 68-22/PT
2. REQUIRED FOR TELEPHONE COMMUNICATION WITH SWITCHBOARD
3. * PART OF AN/GR-6

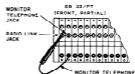

Figure 6-18. AN/GR-6 and receiver-transmitter remote radio control and RWI connections and control settings

Change 3

6-22-1

TM 11-5820-498-12

TM 11-5820-498-12

WARNING

POTENTIAL AS HIGH AS 45 VDC EXIST ON THESE WIRES WHEN THE RADIO IS KEYS UP AND AS HIGH AS 60 VAC WHEN TELEPHONE RINGING IS USED

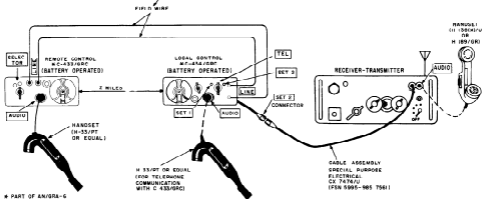

A REMOTE CONTROL CONNECTIONS

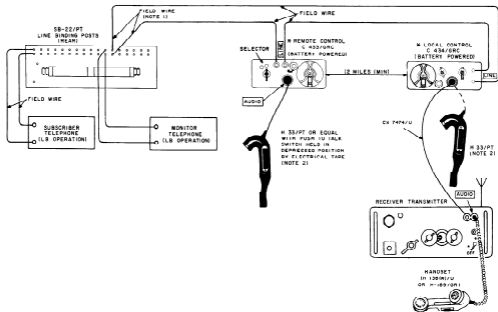

B RWI CONNECTIONS

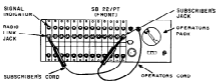

C SWITCHBOARD CONNECTIONS FOR SUBSCRIBER RADIO LINK RWI

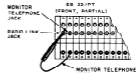

D CORD CONNECTION FOR MONITOR TELEPHONE

NOTES

- 1 IF BY 506/PAC-25 IS KEYS THROUGH CONNECTION OF THESE WIRES AT 5B-22/PT
- 2 REQUIRED FOR TELEPHONE COMMUNICATION WITH SWITCHBOARD
- 3 PART OF AN/ORA-6 AN/GR-3 THRU 8

Figure 6-7A AN/GR-6 and AN/GR-3 and remote control radio control and RWI connections and control settings

Change 3

6-22 1

**6-29. Cable Assembly, Special Purpose,
Electrical CX-7621/VRC**

The CX-7621/VRC is used to connect a C-2297/VRC to an external lamp. It is 4 feet long and has a 4-terminal male connector at one end and a pair of tin leads at the other.

**6-30. Cable Assembly, Radio Frequency
CG-1 773/U**

The CG-1773/U is described in paragraph 1-13. It is illustrated in figures 1-12 and 6-14.

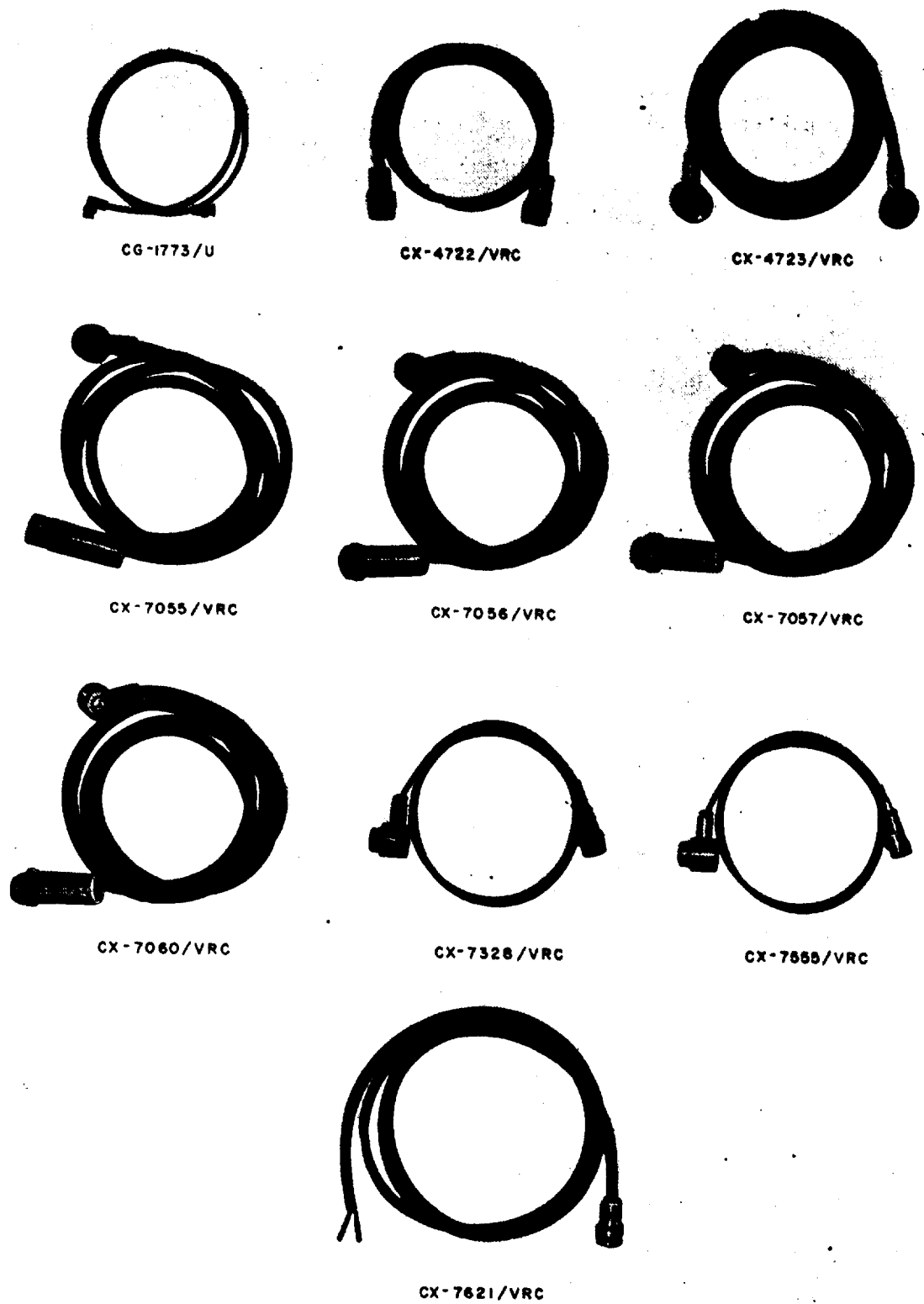

TM5820-498-10-14

Figure 6-14. Cables provided in installation kits for use with radio sets, amplifier-power supply, and interco system.

**APPENDIX A
REFERENCES**

DA PAM 25-30	Consolidated Index of Army Publications and Blank Forms.
DA PAM 738-750 FM 24-18	The Army Maintenance Management System (TAMMS). Tactical Single-Channel Radio Communication Techniques.
SB 11-131 SB 11-576	Vehicular Radio Sets and Authorized Installations Cold Weather Batteries for Radio Sets AN/PRC-6, 8, 8A, 9A, 10, 10A, 25, 28, and 77 and Cable Assemblies for Cold Weather Operation of Transmitting Set, Radio, AN/PRT-4 and Receiving Set, Radio, AN/PRR-9.
TB 43-0118	Field Instructions for Painting and Preserving Communications-Electronics Equipment.
TB 43-0129	Safety Measures to be Observed When Installing and Using Whip Antennas, Field Type Masts, Towers, Antennas, and Metal Poles that are used with Communication, Radar, and Direction Finding Equipment.
TM 10-8400-201-23	Organizational and Direct Support Maintenance Manual: General Repair Procedures.
TM 11-284	Radio Sets AN/GRC-3, -4, -5, -6, -7, and -8.
TM 11-285	Radio Set AN/VRC-7.
TM 11-286	Radio Sets AN/VRC-8, AN/VRC-9, and AN/VRC-10.
TM 11-287	Radio Sets AN/VRQ-1, AN/VRQ-2, and AN/vRQ-3.
TM 11-290	Field Maintenance: Receiver-Transmitters RT-70/GRC, RT-70A/GRC, and Radio Receiver-Transmitter RT-70B/GRC.
TM 11-291	Radio Sets AN/VRC-13, AN/VRC-14, and AN/VRC-15.
TM 11-296	Operator's and Organizational Maintenance Manual (Including Repair Parts and Special Tools Lists) for Radio Set AN/PRC-6.
TM 11-611	Radio Sets AN/VRC-16, AN/VRC-17, and AN/VRC-18.
TM 11-642	Radio Sets AN/VRC-20, AN/VRC-21, and AN/VRC-22.
TM 11-5135-15	Radio Set Control AN/GSA-7 (NSN 5820-00-543-1397).
TM 11-5805-262-12	Operator's and Organizational Maintenance Manual for Switchboard, Telephone, Manual SB-22/PT (NSN 5805-00-257-3602) and SB-22A/PT (NSN 5805-00-715-6171).
TM 11-5820-292-10	Operator's Manual: Radio Sets AN/PRC-8, -8A, -9, -9A, -10, -10A, and -28.
TM 11-5820-348-15	Operator's, Organizational, Direct Support, General Support and Depot Maintenance Manual: Antenna Equipment RC-292 (NSN 5985-00-497-8554).
TM 11-5820-398-12	Operator's and Organizational Maintenance Manual (Including Repair Parts and Special Tools Lists) for Radio Set AN/PRC-25 (NSN 5820-00-857-0759) (Including Receiver-Transmitter, Radio, RT-505/PRC-25 NSN 5820-00-857-0934).

TM 11-5820-498-12

- TM 11-5820-401-10-1 Operator's Manual for Radio Sets AN/VRC-12 (NSN 5820-00-223-7412) , AN/VRC-43 (NSN 5820-00-223-7415), AN/VRC-44 (NSN 5820-00-223-7417), AN/VRC-45 (NSN 5820-00-223-7418), AN/VRC-46 (NSN 5820-00-223-7433), AN/VRC-47 (NSN 5820-00-223-7434), AN/VRC-48 (NSN 5820-00-223-7435), and AN/VRC-49 (NSN 5820-00-223-7437) (Used Without Intercom System).
- TM 11-5820-401-10-2 Operator's Manual for Radio Sets AN/VRC-12 (NSN 5820-00-223-7412) , AN/VRC-43 (NSN 5820-00-223-7415) , AN/VRC-44 (NSN 5820-00-223-7417), AN/VRC-45 (NSN 5820-00-223-7418), AN/VRC-46 (NSN 5820-00-223-7433), AN/VRC-47 (NSN 5820-00-223-7434), AN/VRC-48 (NSN 5820-00-223-7435), and AN/VRC-49 (NSN 5820-00-223-7437) (Used With an Intercom System).
- TM 11-5820-401-20-1 Organizational Maintenance Manual for Radio Sets AN/VRC-12 (NSN 5820-00-223-7412), AN/VRC-43 (NSN 5820-00-223-7415), AN/VRC-44 (NSN 5820-00-223-7417), AN/VRC-45 (NSN 5820-00-223-7418), AN/VRC-46 (NSN 5820-00-223-7433) , AN/VRC-47 (NSN 5820-00-223-7434), AN/VRC-48 (NSN 5820-00-223-7435), AN/VRC-49 (NSN 5820-00-223-7437) (Used Without Intercom System).
- TM 11-5820-401-20-2 Organizational Maintenance Manual for Radio Sets AN/VRC-12 (NSN 5820-00-223-7412), AN/VRC-43 (NSN 5820-00-223-7415) , AN/VRC-44 (NSN 5820-00-223-7417), AN/VRC-45 (NSN 5820-00-223-7418), AN/VRC-46 (NSN 5820-00-223-7433), AN/VRC-47 (NSN 5820-00-223-7434), AN/VRC-48 (NSN 5820-00-223-7435), AN/VRC-49 (NSN 5820-00-223-7437) (Used With an Intercom System).
- TM 11-5820-477-12 Operator's and Organizational Maintenance Manual for Radio Set Control Groups AN/GRA-39 (NSN 5820-00-889-3860), AN/GRA-39A (NSN 5820-00-082-3998), and AN/GRA-39B (NSN 5820-00-949-9909).
- TM 11-5820-498-20P Organizational Maintenance Repair Parts and Special Tools List for Radio Sets AN/VRC-53 (NSN 5820-00-223-7467) , AN/VRC-64 (NSN 5820-00-223-7475), AN/GRC-125 (NSN 5820-00-223-7411), and AN/GRC-160 (NSN 5820-00-223-7473) and Amplifier, Power Supply Groups OA-3633/GRC and OA-3633A/GRC (Parts List for OA-3633/GRC and OA-3633A/GRC, NSN 5820-00-973-3383, only).
- TM 11-5820-549-12 Operator's and Organizational Maintenance Manual: Receiving Set, Radio AN/PRR-9 and Transmitting Sets, AN/PRT-4 and AN/PRT-4A.
- TM 11-5820-667-12 Operator's and Organizational Maintenance Manual: Radio Set AN/PRC-77 (NSN 5820-00-930-3724) (Including Receiver-Transmitter, Radio RT-841/PRC-77 NSN 5820-00-930-3725) I
- TM 11-5820-713-15 Operator's, Organizational, Direct Support, General Support and Depot Maintenance Manual: Radio Terminal Set AN/GRC-163 (NSN 5820-00-832-5617).
- TM 11-5820-882-10 Operator's Manual: Radio Set AN/PRC-68.
- TM 11-5820-882-10-1 Operator's Manual and Components List: Radio Set AN/PRC-68A (NSN 5820-01-180-8943).

TM 11-5820-1025-10	Operator's Manual: Radio Set AN/PRC-126 (NSN 5826-01-215-6181).
TM 11-5821-204-12	Operator's and Organizational Maintenance Manual for Radio Terminal AN/ARC-44.
TM 11-5821-244-12	Operator's and Organizational Maintenance Manual for Radio Set AN/ARC-54 (NSN 5821-00-082-3598).
TM 11-5821-259-12	Operator's and Aviation Intermediate Maintenance Manual for Radio Sets AN/ARC-114 (NSN 5821-00-935-5071) and AN/ARC-114A (NSN 5821-00-165-2970).
TM 11-5821-285-12	Operator's and Organizational Maintenance Manual for Communications Central AN/ASC-15.
TM 11-5830-340-12	Operator's and Organizational Maintenance Manual for Intercommunication Set AN/VIC-I(V) (NSN 5830-00-856-3273); Control, Intercommunication Set C-10456/VRC (NSN 5830-01-082-0804), C-10680/VRC and Amplifier, Audio Frequency AM-7046/VRC.
TM 11-5895-474-12	Operator's and Organizational Maintenance Manual for Landing Control Central AN/TSQ-71A (NSN 5895-00-054-9366) .
TM 11-5895-579-12	Operator's and Organizational Maintenance Manual: Aircraft Control Central AN/TSQ-70A (NSN 5895-00-054-9366) .
TM 11-5895-590-10	Operator's Manual Air Traffic Control Communication Sets AN/FSQ-75(V)1, AN/FSQ-75(V)2, and AN/FSQ-75(V)3.
TM 11-5965-257-15	Operator's, Organizational, Direct Support, General Support, and Depot Maintenance Manual (Including Repair Parts and Special Tools Lists): Headset H-138/U (NSN 5965-00-892-0972).
TM11-5965-260-24P	Organizational, Direct Support, and General Support Maintenance Repair Parts and Special Tools Lists (Including Depot Maintenance Repair Parts and Special Tools) for Headset, Electrical, H-140A/U (NSN 5965-00-892-1010).
TM 11-5965-262-13	Operator's, Organizational, and Direct Support Maintenance Manual (Including Repair Parts and Special Tools List): Headset-Microphone H-161/U and H-161A/U (NSN 5965-00-082-4037 and 5965-00-824-4871) .
TM 11-5965-280-15	Operator's, Organizational, Direct Support, General Support, and Depot Maintenance Manual (Including Repair Parts and Special Tools List): Headset H-189/GR (NSN 5965-00-069-8886).
TM 11-5965-282-15	Operator's, Organizational, Direct Support, General Support, and Depot Maintenance Manual (Including Repair Parts and Special Tools List): Headset, Microphone Kit MK-1039/G.
TM 11-5965-286-14	Operator's, Organizational, Direct Support, and General Support Maintenance Manual (Including Repair Parts and Special Tools List): Headset, Microphone Kit MK-1697/G (NSN 5965-00-313-8958).

TM 11-5820-498-12

- TM 11-5985-262-14 Operator's, Organizational, Direct Support, and General Support Maintenance Manual: Antenna AS-1729/VRC (NSN 5985-00-985-9024).
- TM 11-5985-284-15 Operator's, Organizational, Direct Support, General Support, and Depot Maintenance Manual: Antenna, LOOP AT-784/PRC (NSN 5820-00-086-7651).
- TM 11-5985-357-13 Operator's, Organizational, and Direct Support Maintenance Manual for Antenna Group OE-254/GRC (NSN 5985-01-063-1574).
- TM 11-5995-202-15 Operator's, Organizational, Direct Support, General Support, and Depot Maintenance Manual for Transmission Cable Kits MK-456/GRC and MK-456A/GRC (NSN 5995-00-973-1544).
- TM 11-6130-233-12 Operator's and Organizational Maintenance Manual: Power Supplies PP-2953/u, PP-2953A/U, PP-2953B/U, and PP-2953C/U (NSN 6130-00-985-7899).
- TM 11-6625-514-12 Operator's and Organizational Maintenance Manual: Test Sets, Electronic Circuit Plug-In Units AN/GRM-55, AN/GRM-55A, AN/GRM-55B, and ANIGRM-55C.
- TM 11-6625-3015-14 Operator's, Organizational, Direct Support, and General Support Maintenance Manual for Radio Test Set AN/PRM-34 (NSN 6625-01-094-5646).
- TM 11-6625-3052-14 Operator's, Organizational, Direct Support, and General Support Maintenance Manual for Multimeter, Digital AN/PSM-45 (NSN 6625-01-139-2512).
- TM 750-244-2 Procedures for Destruction of Electronics Materiel to Prevent Enemy Use (Electronics Command).

APPENDIX B

COMPONENTS OF END ITEM LIST

Section I. INTRODUCTION

B-1. Scope

This appendix lists integral components of and basic issue items for the AN/VRC-53, AN/VRC-64, AN/GRC-125, AN/GRC-160, and OA-3633/GRC, and OA-3633A/GRC to help you inventory items required for safe and efficient operation.

B-2. General

This Components of End Item List is divided into the following sections:

a. Section II. Integral Components of the End Item. Not applicable. These items, when assembled, comprise the AN/VRC-53, AN/VRC-64, AN/GRC-125, AN/GRC-160, and OA-3633/GRC, and OA-3633A/GRC and must accompany it whenever it is transferred or turned in. The illustrations will help you identify these items.

b. Section III. Basic Issue Items. Not applicable.

B-3. Explanation of Columns

a. Illustration. This column is divided as follows

(1) *Figure number.* Indicates the figure number of the illustration on which the item is shown.

(2) *Item number.* Not applicable.

b. National Stock Number. Indicates the National stock number assigned to the item and which will be used for requisitioning.

c. Part Number. Indicates the Federal item name and, if required, a minimum description to identify the item. The part number indicates the primary number used by the manufacturer, which controls the design and characteristics of the item by means of its engineering drawings, specifications, standards, and inspection requirements to identify an item or range of items. Following the part number, the Federal Supply Code for Manufacturers (FSCM) is shown in parentheses.

d. Description. Indicates the Federal item name and, if required, a minimum description to identify the item.

e. Location. Not applicable.

f. Usable on Code. Not applicable.

g. Quantity Required (Qty Reqd). This column lists the quantity of each item required for a complete major item.

h. Quantity. This column is left blank for use during an inventory. Under the Rcvd column, lists the quantity you actually receive on your major item. The Date columns are for your use when you inventory the major item.

(Next printed page is B-3.)

SECTION II INTEGRAL COMPONENTS OF END ITEM AN/VRC-53

(1) ILLUSTRATION		(2) NATIONAL STOCK NUMBER	(3) DESCRIPTION		(4) LOCATION	(5) USABLE ON CODE	(6) QTY REQD	(7) QUANTITY	
(A) FIG NO.	(B) ITEM NO.							PART NUMBER	(FSCM)
1-10		5820-00-223-7467	RADIO SET AN/VRC-53	(80063)					
1-10		5820-00-973-3383	AMPLIFIER-POWER SUPPLY GROUP OA-3633/GRC INCLUDES:	(80063)					
1-10		5820-00-973-3384	AMPLIFIER-POWER SUPPLY AM-2060/GRC	(80063)					
1-10		5995-00-889-1061	CABLE ASSEMBLY, SPECIAL PURPOSE, ELECTRICAL CX-4655/GRC	(80063)					
			OR						
1-10		5820-00-973-3383	AMPLIFIER-POWER SUPPLY GROUP OA-3633A/GRC INCLUDES:	(80063)					
1-10		5820-00-973-3384	AMPLIFIER-POWER SUPPLY AM-2060A/GRC	(80063)					
1-10		5995-00-889-1061	CABLE ASSEMBLY, SPECIAL PURPOSE, ELECTRICAL CX-4655/GRC	(80063)					
1-6		5820-00-857-0934	RECEIVER-TRANSMITTER, RADIO RT-505/PRC-25 INCLUDES:	(80063)					
1-6		5820-00-086-7148	BATTERY BOX CY-2562/PRC-25	(80063)					
1-10		5985-00-985-9024	ANTENNA AS-1729/VRC INCLUDES:	(80063)					
1-10		5820-00-856-2728	ANTENNA ELEMENT AT-1095/VRC	(80063)					
1-10		5985-00-985-9022	ANTENNA ELEMENT AS-1730/VRC	(80063)					
1-10		5820-00-906-1115	MATCHING UNIT-BASE, ANTENNA MX-6707/VRC	(80063)					
1-10		5820-00-908-6416	ANTENNA TIE-DOWN KIT SC-C-208747	(80063)					
1-10		5820-00-437-2353	ANTENNA TIP CAP SC-C-446180	(80063)					
1-10		5985-01-012-5425	STEEL REINFORCING RING SC-C-877429	(80063)					
			PART OF MX-6707/VRC (INSTALLATION HARDWARE):						
		5306-00-225-9084	SCREW, MACHINE MS90726-29	(96906)					
		5310-00-732-0558	NUT, HEXAGON MS51967-8	(96906)					
		5310-00-637-9541	WASHER, LOCK MS35338-46	(96906)					
		5310-00-880-7746	NUT, HEXAGON MS51968-5	(96906)					
		5306-00-225-9084	SCREW, MACHINE MS90726-29	(96906)					
		5310-00-080-9785	WASHER, LOCK MS45904-60	(96906)					
		5310-00-889-2527	WASHER, LOCK MS45904-72	(96906)					
		5995-00-192-9614	LEAD, ELECTRICAL SMC283109	(80063)					
		5330-00-078-4184	GASKET, RUBBER SMB160382	(80063)					

SECTION III INTEGRAL COMPONENTS OF END ITEM AR/VRC- 64

(1) ILLUSTRATION		(2) NATIONAL STOCK NUMBER	(3) DESCRIPTION PART NUMBER (FSCM)	(4) LOCATION	(5) USABLE ON CODE	(6) QTY REQD	(7) QUANTITY	
(A) FIG NO.	(B) ITEM NO.						RCVD	DATE
1-10		5820-00-223-7475	RADIO SET AM/VRC- 64 (80063)					
1-10		5820-00-973-3383	AMPLIFIER-POWER SUPPLY GROUP OA-3633/GRC INCLUDES: (80063)					
1-10		5820-00-973-3384	AMPLIFIER-POWER SUPPLY AM-2060/GRC (80063)					
1-10		5995-00-889-1061	CABLE ASSEMBLY, SPECIAL PURPOSE, ELECTRICAL CX-4655/GRC (80063)					
			OR					
1-10		5820-00-973-3383	AMPLIFIER-POWER SUPPLY GROUP OA-3633A/GRC INCLUDES: (80063)					
1-10		5820-00-973-3384	AMPLIFIER-POWER SUPPLY AM-2060A/GRC (80063)					
1-10		5995-00-889-1061	CABLE ASSEMBLY, SPECIAL PURPOSE, ELECTRICAL CX-4655/GRC (80063)					
1-6		5820-00-930-3725	RECEIVER-TRANSMITTER, RADIO RT-841/PRC-77 INCLUDES: (80063)					
1-6		5820-00-086-7148	BATTERY BOX CY-2562/PRC-25 (80063)					
1-10		5985-00-985-9024	ANTENNA AS-1729/VRC INCLUDES: (80063)					
1-10		5820-00-856-2728	ANTENNA ELEMENT AT-1095/VRC (80063)					
1-10		5985-00-985-9022	ANTENNA ELEMENT AS-1730/VRC (80063)					
1-10		5820-00-906-1115	MATCHING UNIT-BASE, ANTENNA MX-6707/VRC (80063)					
1-10		5820-00-908-6416	ANTENNA TIE-DOWN KIT SC-C-208747 (80063)					
1-10		5820-00-437-2353	ANTENNA TIP CAP SC-C-446180 (80063)					
1-10		5985-01-012-5425	STEEL REINFORCING RING SC-C-877429 (80063)					
			PART OF MX-6707/VRC (INSTALLATION HARDWARE):					
		5306-00-225-9084	SCREW, MACHINE MS90726-29 (96906)					
		5310-00-732-0558	NUT, HEXAGON MS51967-8 (96906)					
		5310-00-637-9541	WASHER, LOCK MS35338-46 (96906)					
		5310-00-880-7746	NUT, HEXAGON MS51968-5 (96906)					
		5306-00-225-9084	SCREW, MACHINE MS90726-29 (96906)					
		5310-00-080-9785	WASHER, LOCK MS45904-60 (96906)					
		5310-00-889-2527	WASHER, LOCK MS45904-72 (96906)					
		5995-00-192-9614	LEAD, ELECTRICAL SMC283109 (80063)					
		5330-00-078-4184	GASKET, RUBBER SMD160382 (80063)					

SECTION IV INTEGRAL COMPONENTS OF END ITEM AN/GRC-125

(1) ILLUSTRATION		(2) NATIONAL STOCK NUMBER	(3) DESCRIPTION		(4) LOCATION	(5) USABLE ON CODE	(6) QTY REQD	(7) QUANTITY	
(A) FIG NO.	(B) ITEM NO.		PART NUMBER	(FSCM)				RCVD	DATE
1-10		5820-00-223-7411	RADIO SET AN/GRC-125	(80063)					
1-10		5820-00-973-3383	AMPLIFIER-POWER SUPPLY GROUP OA-3633/GRC INCLUDES:	(80063)					
1-10		5820-00-973-3384	AMPLIFIER-POWER SUPPLY AM-2060/GRC	(80063)					
1-10		5995-00-889-1061	CABLE ASSEMBLY, SPECIAL PURPOSE, ELECTRICAL CX-4655/GRC	(80063)					
			OR						
1-10		5820-00-973-3383	AMPLIFIER-POWER SUPPLY GROUP OA-3633A/GRC INCLUDES:	(80063)					
1-10		5820-00-973-3384	AMPLIFIER-POWER SUPPLY AM-2060A/GRC	(80063)					
1-10		5995-00-889-1061	CABLE ASSEMBLY, SPECIAL PURPOSE, ELECTRICAL CX-4655/GRC	(80063)					
1-10		5985-00-985-9021	ANTENNA AS-1729/VRC INCLUDES:	(80063)					
1-10		5820-00-856-2728	ANTENNA ELEMENT AT-1095/VRC	(80063)					
1-10		5985-00-985-9022	ANTENNA ELEMENT AS-1730/VRC	(80063)					
1-10		5820-00-906-1115	MATCHING UNIT-BASE ANTENNA MX-6707/VRC	(80063)					
1-10		5820-00-908-6416	ANTENNA TIE-DOWN KIT SC-C-208747	(80063)					
1-10		5820-00-437-2353	ANTENNA TIP CAP SC-C-446180	(80063)					
1-10		5985-01-012-5425	STEEL REINFORCING RING SC-C-877429	(80063)					
			PART OF MX-6707/VRC (INSTALLATION HARDWARE):						
		5306-00-225-9084	SCREW, MACHINE MS90726-29	(96906)					
		5310-00-732-0558	NUT, HEXAGON MS51967-8	(96906)					
		5310-00-637-9541	WASHER, LOCK MS35338-46	(96906)					
		5310-00-880-7746	NUT, HEXAGON MS51968-5	(96906)					
		5306-00-225-9084	SCREW, MACHINE MS90726-29	(96906)					
		5310-00-080-9785	WASHER, LOCK MS45904-60	(96906)					
		5310-00-889-2527	WASHER, LOCK MS45904-72	(96906)					
		5995-00-192-9614	LEAD, ELECTRICAL SMC283109	(80063)					
		5330-00-078-4184	GASKET, RUBBER SMB160382	(80063)					
1-13		5820-00-857-0759	RADIO SET AN/PRC-25 INCLUDES:	(80063)					
1-13		5820-00-857-0934	RECEIVER-TRANSMITTER, RADIO RT-505/PRC-25 INCLUDES:						
1-13		5820-00-086-7148	BATTERY BOX CY-2562/PRC-25						
1-13		5820-00-889-3803	ANTENNA AT-892/PRC-25	(80063)					
1-13		5820-00-242-4967	ANTENNA AT-271A/PRC INCLUDES:	(80063)					
1-13		5820-00-086-7149	SUPPORT, ANTENNA AB-591/PRC-25	(80063)					
1-13		5965-00-043-3463	HANDSET H-250/U	(80063)					
1-13		5820-00-086-7138	BAG, COTTON DUCK CW-503/PRC-25	(80063)					

SECTION IV INTEGRAL COMPONENTS OF END ITEM AN/GRC-160

(1) ILLUSTRATION		(2) NATIONAL STOCK NUMBER	(3) DESCRIPTION		(4) LOCATION	(5) USABLE ON CODE	(6) QTY REQD	(7) QUANTITY	
(A) FIG NO.	(B) ITEM NO.							RCVD	DATE
1-10		5820-00-223-7473	RADIO SET AN/GRC-160	(80063)					
1-10		5820-00-973-3383	AMPLIFIER-POWER SUPPLY GROUP OA-3633/GRC Includes:	(80063)					
1-10		5820-00-973-3384	AMPLIFIER-POWER SUPPLY AM-2060/GRC	(80063)					
1-10		5995-00-889-1061	CABLE ASSEMBLY, SPECIAL PURPOSE, ELECTRICAL CX-4655/GRC	(80063)					
			OR						
1-10		5820-00-973-3383	AMPLIFIER-POWER SUPPLY GROUP OA-3633A/GRC Includes:	(80063)					
1-10		5820-00-973-3384	AMPLIFIER-POWER SUPPLY AM-2060A/GRC	(80063)					
1-10		5995-00-889-1061	CABLE ASSEMBLY, SPECIAL PURPOSE, ELECTRICAL CX-4655/GRC	(80063)					
1-10		5985-00-985-9024	ANTENNA AS-1729/VRC Includes:	(80063)					
1-10		5820-00-856-2728	ANTENNA ELEMENT AT-1095/VRC	(80063)					
1-10		5895-00-985-9022	ANTENNA ELEMENT AS-1730/VRC	(80063)					
1-10		5820-00-906-1115	MATCHING UNIT-BASE, ANTENNA MX-6707/VRC	(80063)					
1-10		5820-00-908-6416	ANTENNA TIE-DOWN KIT SC-C-208747	(80063)					
1-10		5820-00-437-2353	ANTENNA TIP CAP SC-C-446180	(80063)					
1-10		5985-01-017-5425	STEEL REINFORCING RING SC-C-877429	(80063)					
			PART OF MX-6707/VRC (INSTALLATION HARDWARE):						
		5306-00-225-9084	SCREW, MACHINE MS90726-29	(96906)					
		5310-00-732-0558	NUT, HEXAGON MS51967-8	(96906)					
		5310-00-637-9541	WASHER, LOCK MS35338-46	(96906)					
		5310-00-880-7746	NUT, HEXAGON MS51968-5	(96906)					
		5306-00-225-9084	SCREW, MACHINE MS90726-29	(96906)					
		5310-00-080-9785	WASHER, LOCK MS45904-60	(96906)					
		5310-00-889-2527	WASHER, LOCK MS45904-72	(96906)					
		5995-00-192-9614	LEAD, ELECTRICAL SM0283109	(80063)					
		5330-00-078-4184	GASKET, RUBBER SMB160382	(80063)					
1-13		5820-00-930-3724	RADIO SET AN/PRC-77 Includes:	(80063)					
1-13		5820-00-930-3725	RECEIVER-TRANSMITTER, RADIO RT-841/PRC-77 Includes:						
1-13		5820-00-086-7148	BATTERY BOX CY-2562/PRC-25						
1-13		5820-00-889-3803	ANTENNA AT-892/PRC-25	(80063)					
1-13		5820-00-242-4967	ANTENNA AT-271A/PRC Includes:	(80063)					
1-13		5820-00-086-7149	SUPPORT ANTENNA AB-591/PRC-25	(80063)					
1-13		5965-00-043-3463	HANDSET H-250/U	(80063)					
1-13		5820-00-086-7138	BAG, COTTON DUCK CW-502/PRC-25	(80063)					

APPENDIX C

MAINTENANCE ALLOCATION

Section I. INTRODUCTION

C-1. General.

This appendix provides a summary of the maintenance operations for Radio Sets AN/GRC-125, AN/GRC160, AN/VRC-53, and AN/VRC-64, and Amplifier-Power Supply Groups OA-3633/GRC and OA-3633A/GRC (part of radio sets). It authorizes categories of maintenance for specific maintenance functions on repairable items and components and the tools and equipment required to perform each function. This appendix may be used as an aid in planning maintenance operations.

C-2. Maintenance Function.

Maintenance functions will be limited to and defined as follows:

a. Inspect. To determine the serviceability of an item by comparing its physical, mechanical, and/or electrical characteristics with established standards through examination.

b. Test. To verify serviceability and to detect incipient failure by measuring the mechanical or electrical characteristics of an item and comparing those characteristics with prescribed standards.

c. Service. Operations required periodically to keep an item in proper operating condition, i.e., to clean (decontaminate), to preserve, to drain, to paint, or to replenish fuel, lubricants, hydraulic fluids, or compressed air supplies.

d. Adjust. To maintain, within prescribed limits, by bringing into proper or exact position, or by setting the operating characteristics to the specified parameters.

e. Align. To adjust specified variable elements of an item to bring about optimum or desired performance.

f. Calibrate. To determine and cause corrections to be made or to be adjusted on instruments or test measuring and diagnostic equipments used in precision measurement. Consists of comparisons of two instruments, one of which is a certified standard of known accuracy, to detect and adjust any discrepancy in the accuracy of the instrument being compared.

g. Install. The act of emplacing, seating, or fixing into position an item, part, module (component or assembly) in a manner to allow the proper functioning of the equipment or system.

h. Replace. The act of substituting a serviceable like type part, subassembly, or module (component or assembly) for an unserviceable counterpart.

i. Repair. The application of maintenance services (inspect, test, service, adjust, align, calibrate, replace) or other maintenance actions (welding, grinding, riveting, straightening, facing, remachining, or resurfacing) to restore serviceability to an item by correcting specific damage, fault, malfunction, or failure in a part, subassembly, module (component or assembly), end item, or system. This function does not include the trial and error replacement of running spare type items such as fuses, lamps or electron tubes.

j. Overhaul. That maintenance effort (service/action) necessary to restore an item to a completely serviceable/operational condition as prescribed by maintenance standards (i.e., DMWR) in appropriate technical publications. Overhaul is normally the highest degree of maintenance performed by the Army. Overhaul does not normally return an item to like new condition.

k. Rebuild. Consists of those services/actions necessary for the restoration of unserviceable

equipment to a like new condition in accordance with original manufacturing standards. Rebuild is the highest degree of materiel maintenance applied to Army equipment. The rebuild operation includes the act of returning to zero those age measurements (hours, miles, etc.) considered in classifying Army equipments/components.

C-3. Column Entries.

a. Column 1, Group Number. Column 1 lists group numbers, the purpose of which is to identify components, assemblies, subassemblies, and modules with the next higher assembly.

b. Column 2, Component/Assembly. Column 2 contains the noun names of components, assemblies, subassemblies, and modules for which maintenance is authorized.

c. Column 3, Maintenance Functions. Column 3 lists the functions to be performed on the item listed in column 2. When items are listed without maintenance functions, it is solely for purpose of having the group numbers in the MAC and RPSTL coincide.

d. Column 4, Maintenance Category. Column 4 specifies, by the listing of a "work time" figure in the appropriate subcolumn(s), the lowest level of maintenance authorized to perform the function listed in column 3. This figure represents the active time required to perform that maintenance function at the indicated category of maintenance. If the number or complexity of the tasks within the listed maintenance function vary at different maintenance categories, appropriate "work time" figures will be shown for each category. The number of task-hours specified by the "work-time" figure represents the average time required to restore an item (assembly, subassembly, component, module, end item or system) to a serviceable condition under typical field operating conditions. This time includes preparation time, troubleshooting time, and quality assurance/quality control time in addition to the time required to perform the specific tasks identified for the maintenance functions authorized in the maintenance allocation chart. Subcolumns of column 4 are as follows:

- C-Operator/Crew
- O-Organizational
- F—Direct Support
- H-General Support
- D-Depot

e. Column 5, Tools and Equipment. Column 5 specifies by code, those common tool sets (not individual tools) and special tools, test, and support equipment required to perform the designated function.

f. Column 6, Remarks. Column 6 contains an alphabetic code which leads to the remark in section IV, Remarks, which is pertinent to the item opposite the particular code.

C4. Tool and Test Equipment Requirements (See III).

a. Tool or Test Equipment Reference Code. The numbers in this column coincide with the numbers used in the tools and equipment column of the MAC. The numbers indicate the applicable tool or test equipment for the maintenance functions.

b. Maintenance Category. The codes in this column indicate the maintenance category allocated the tool or test equipment.

c. Nomenclature. This column lists the noun name and nomenclature of the tools and test equipment required to perform the maintenance functions.

d. National/NATO Stock Number. This column lists the National/NATO stock number of the specific tool or test equipment.

e. Tool Number. This column lists the manufacturer's part number of the tool followed by the Federal Supply Code for manufacturers (5-digit) in parentheses.

C-5. Remarks (See IV).

a. Reference Code. This code refers to the appropriate item in section II, column 6.

b. Remark-s. This column provides the required explanatory information necessary to clarify items appearing in section II.

(Next printed page is C-3.)

SECTION II MAINTENANCE ALLOCATION CHART
FOR
RADIO SET AN/GRC-125

TM 11-5820-498-12

(1) GROUP NUMBER	(2) COMPONENT/ASSEMBLY	(3) MAINTENANCE FUNCTION	(4) MAINTENANCE CATEGORY					(5) TOOLS AND EQUIPMENT
			C	O	F	H	D	
00	RADIO SET AN/GRC-125							
01	RADIO SET AN/PRC-25 (SEE TM 11-5820-398-12 for MAINTENANCE FUNCTION)							
02	AMPLIFIER-POWER SUPPLY GROUP OA-3633/GRC OR OA-3633A/GRC (SEE Section VI for MAINTENANCE)							
03	ANTENNA AS-1729/VRC (SEE TM 11-5985-262-14 for MAINTENANCE FUNCTIONS)							

SECTION III MAINTENANCE ALLOCATION CHART
 FOR
 RADIO SET AN/GRC-160

(1) GROUP NUMBER	(2) COMPONENT/ASSEMBLY	(3) MAINTENANCE FUNCTION	(4) MAINTENANCE CATEGORY					(5) TOOLS AND EQUIPMENT
			C	O	F	H	D	
00	RADIO SET AN/GRC-160							
01	RADIO SET AN/PRC-77 (SEE TM 11-5820-667-12 for MAINTENANCE FUNCTIONS)							
02	AMPLIFIER-POWER SUPPLY GROUP OA-3633/GRC OR OA-3633A/GRC (SEE Section VI for MAINTENANCE FUNCTIONS)							
03	ANTENNA AS-1729/VRC (SEE TM 11-5985-262-14 for MAINTENANCE FUNCTIONS)							

SECTION IV MAINTENANCE ALLOCATION CHART
FOR
RADIO SET AN/VRC-53

TM 11-5820-498-12

(1) GROUP NUMBER	(2) COMPONENT/ASSEMBLY	(3) MAINTENANCE FUNCTION	(4) MAINTENANCE CATEGORY					(5) TOOLS AND EQUIPMENT
			C	O	F	H	D	
00	RADIO SET AN/VRC-53							
01	RECEIVER-TRANSMITTER, RADIO RT-505/PRC-25 (SEE TM 11-5820-398-12 for MAINTENANCE FUNCTIONS)							
02	AMPLIFIER-POWER SUPPLY GROUP OA-3633/GRC OR OA-3633A/GRC (SEE Section VI for MAINTENANCE FUNCTIONS)							
03	ANTENNA AS-1729/VRC (SEE TM 11-5985-262-14 for MAINTENANCE FUNCTIONS)							

SECTION V. MAINTENANCE ALLOCATION CHART
 FOR
 RADIO SET AN/VRC-64

(1) GROUP NUMBER	(2) COMPONENT/ASSEMBLY	(3) MAINTENANCE FUNCTION	(4) MAINTENANCE CATEGORY					(5) TOOLS AND EQUIPMENT
			C	O	F	H	D	
00	RADIO SET AN/VRC-64							
01	RECEIVER-TRANSMITTER, RADIO RT-841/PRC-77 (SEE TM 11-5820-667-12 for MAINTENANCE FUNCTIONS)							
02	AMPLIFIER-POWER SUPPLY GROUP OA-3633/GRC OR OA-3633A/GRC (SEE Section VI for MAINTENANCE FUNCTIONS)							
03	ANTENNA AS-1729/VRC (SEE TM 11-5985-262-14 for MAINTENANCE FUNCTIONS)							

TABLE 1. TOOL AND TEST EQUIPMENT REQUIREMENTS
FOR
AMPLIFIER-POWER SUPPLY GROUPS OA-3633/GRC AND OA-3633A/GRC

TOOL OR TEST EQUIPMENT REF CODE	MAINTENANCE CATEGORY	NOMENCLATURE	NATIONAL/NATO STOCK NUMBER	TOOL NUMBER
1	O	TOOL KIT, ELECTRONIC EQUIPMENT TK-101/G	6180-00-064-5178	
2	O	MULTIMETER AN/PSM-45 or AN/URM-105	6625-01-139-2512 6625-00-581-2036	
3	F,H,D	TOOL KIT, ELECTRONIC EQUIPMENT TK-100/G	5180-00-605-0079	
4	F,H,D	TOOL KIT, ELECTRONIC EQUIPMENT TK-105/G	5180-00-610-8177	
5	F,H,D	MULTIMETER AN/USM-486 or VOLTMETER, ELECTRONIC ME-30B/U	6625-01-145-2430 6625-00-669-0742	
6	F,H,D	TEST SET, RADIO AN/GRM-114A or GENERATOR, SIGNAL AN/URM-127	6625-01-114-4481 6625-00-783-5965	
7	F,H,D	MULTIMETER AN/USM-486 or ME-26/U	6625-01-145-2430 6625-00-646-9409	
8	F,H,D	TEST SET, RADIO AN/GRM-114A or ANALYZER, SPECTRUM TS-723/U	6625-01-114-4481 6625-00-668-9418	
9	O	TEST SET, RADIO AN/PRM-34(*) or TEST SET, RF POWER AN/URM-182	6625-01-094-5646 6625-00-148-9371	

APPENDIX D

ADDITIONAL AUTHORIZATION LIST

Section I. INTRODUCTION

D-1. Scope

This appendix lists additional items you are authorized for the operation of the AN/VRC-53, AN/VRC-64, AN/GRC-125, and AN/GRC-160 (appx B).

D-2. General

This list identified items that do not have to accompany the equipment (D-1 above) and that do not have to be turned in with it. These items are all authorized to you by CTA, MTOE, TDA, or JTA.

D-3. Explanation of Listing

National stock numbers, descriptions, and quantities are provided to help you identify and request the additional items you require to operate this equipment. See paragraph *1-6b* for an explanation of this list of items which are part of installation kits, necessary kits, and/or vehicle radio/intercom harness required to make the basic radios (para D-1 above) operational.

(Next printed page is D-3.)

SECTION II ADDITIONAL AUTHORIZATION LIST

(1) NATIONAL STOCK NUMBER	(2) DESCRIPTION PART NUMBER AND FSCM	(3) UNIT OF MEAS	(4) QTY AUTH
	ADAPTER		
5235-00-149-3534	UG-273/U (80058)	EA	
5935-00-666-1649	UG-306B/U (80058)	EA	
	AMPLIFIER, AUDIO FREQUENCY (fig. 6-1)		
5820-00-892-3342	AM-1780/VRC (80063)	EA	
	CONTROL, INTERCOMMUNICATION SET (fig. 6-1)		
5820-00-892-3337	C-2296/VRC (80058)	EA	
5820-00-892-3338	C-2297/VRC (80058)	EA	
5820-00-892-3339	C-2298/VRC (80058)	EA	
	HANDSET (fig. 1-14)		
5965-00-069-8886	H-189/GP (80058)	EA	
5965-00-043-3463	H-250/U (81134)	EA	
	HEADSET (fig. 6-2)		
5965-00-891-1010	H-140/U (80058)	EA	
5965-00-0-3-3-60	H-251/U (81134)	EA	
	HEADSET-MICROPHONE (fig. 6-2)		
5965-00-179-3789	H-161/U (80058)	EA	
	HEADSET-MICROPHONE KIT		
5965-00-937-1850	MX-1039/G (81349) (INSTALLED IN CVC HELMET T-56-6)	EA	
5965-00-313-8958	MX-1697/G (80058) (INSTALLED IN AVC HELMET 23-72)	EA	
	HELMET, CREWMAN (PERSONAL USE) (fig. 6-3)		
5310-00-356-4278	T56-6 (79960)	EA	
5415-00-094-2679	23-72 (81337) (MEDIUM WITH SMALL INNER LINER)	EA	
8415-00-094-2691	23-72 (81337) (MEDIUM WITH MEDIUM INNER LINER)	EA	
8415-00-094-2694	23-72 (81337) (LARGE WITH LARGE INNER LINER)	EA	
	MICROPHONE (fig. 6-2)		
5965-00-179-7762	M-80/U (81349)	EA	
	MOUNTING (fig. 1-8)		
5820-00-893-1323	MT-1029 VRC (80063)	EA	
8465-01-073-8326	Pack Frame LC-2 (81349)	EA	1
8465-00-001-6476	Shelf, Cargo Support (81349)	EA	1
8465-00-001-6477	Strap, Webbing, Cargo Tiedown, Lightweight Pack Frame (81349)		2
	SUPPRESSOR, ELECTRICAL TRANSIENT		
5915-00-937-9564	MX-7778/GRC (80063)	EA	
5915-00-431-6708	MX-778A/GRC (80063) OR	EA	
	CABLE ASSEMBLY, RADIO FREQUENCY (fig. 6-14)		
5995-00-823-2986	CG-1773A/U, B/U (3 FT) (80058)	FT	
5995-00-889-1037	CG-1773A/U (4 FT) (80058)	FT	
5995-00-823-2990	CG-1773A/U (8 FT) (80058)	FT	
5995-00-985-8394	CG-1773A/U (16 FT) (80058)	FT	
5995-00-823-2987	CG-1773B/U (4 FT) (80058)	FT	
5995-00-823-2988	CG-1773B/U (5 FT) (80058)	FT	
5995-00-823-2989	CG-1773B/U (6 FT) (80058)	FT	
5995-00-823-2991	CG-1773B/U (7 FT) (80058)	FT	
5995-00-823-3074	CG-1773B/U (9 FT) (80058)	FT	
5995-00-823-3073	CG-1773B/U (10 FT) (80058)	FT	

SECTION II ADDITIONAL AUTHORIZATION LIST

(1) NATIONAL STOCK NUMBER	(2) DESCRIPTION PART NUMBER AND FSCM	(3) UNIT OF MEAS	(4) QTY AUTH
5995-00-823-2992	CG-1773B/U (12 FT) (80058)	FT	
5995-00-926-8310	CG-1773B/U (13 FT) (80058)	FT	
5995-00-985-7551	CG-1773B/U (15 FT) (80058)	FT	
	CABLE ASSEMBLY, POWER, ELECTRICAL (fig. 1-11)		
5995-00-889-0900	CX-4720/VRC (1 FT) (80058)	FT	
5995-00-169-6049	CX-4720/VRC (3 FT) (80058)	FT	
5995-00-889-0708	CX-4720/VRC (4 FT) (80058)	FT	
5995-00-823-2828	CX-4720/VRC (5 FT) (80058)	FT	
5995-00-823-2827	CX-4720/VRC (6 FT) (80058)	FT	
5995-00-889-1148	CX-4720/VRC (8 FT) (80058)	FT	
5995-00-823-2726	CX-4720/VRC (10 FT) (80058)	FT	
5995-00-889-1253	CX-4720/VRC (12 FT) (80058)	FT	
5995-00-823-2854	CX-4720/VRC (14 FT) (80058)	FT	
5995-00-985-8395	CX-4720/VRC (16 FT) (80058)	FT	
5995-00-889-0836	CX-4720/VRC (20 FT) (80058)	FT	
5995-00-987-1299	CX-4720/VRC (30 FT) (80058)	FT	
5995-00-985-7877	CX-4721/VRC (2 FT) (80058)	FT	
5995-00-823-2770	CX-4721/VRC (3 FT) (80058)	FT	
5995-00-832-8945	CX-4721/VRC (5 FT) (80058)	FT	
5995-00-823-2769	CX-4721/VRC (6 FT) (80058)	FT	
5995-00-823-2852	CX-4721/VRC (8 FT) (80058)	FT	
5995-00-823-2912	CX-4721/VRC (10 FT) (80058)	FT	
	CABLE ASSEMBLY, SPECIAL PURPOSE, ELECTRICAL (fig. 6-14)		
5995-00-823-2817	CX-4722/VRC (2 FT) (80058)	FT	
5995-00-823-2824	CX-4722/VRC (3 FT) (80058)	FT	
5995-00-823-2740	CX-4722/VRC (7 FT) (80058)	FT	
5995-00-823-2872	CX-4722/VRC (9 FT) (80058)	FT	
5995-00-823-2818	CX-4722/VRC (10 FT) (80058)	FT	
5995-00-823-9030	CX-4722/VRC (11 FT) (80058)	FT	
5995-00-823-2910	CX-4722/VRC (12 FT) (80058)	FT	
5995-00-985-788	CX-4722/VRC (14 FT) (80058)	FT	
5995-00-985-7618	CX-4722/VRC (15 FT) (80058)	FT	
5995-00-985-8393	CX-4722/VRC (16 FT) (80058)	FT	
5995-00-985-8090	CX-4722/VRC (20 FT) (80058)	FT	
5995-00-985-7880	CX-4722/VRC (30 FT) (80058)	FT	
5995-00-91-7107	CX-4722A/VRC (4 FT) (80058)	FT	
5995-00-91-7106	CX-4722A/VRC (5 FT) (80058)	FT	
5995-00-258-8423	CX-4722A/VRC (6 FT) (80058)	FT	
5995-00-408-2661	CX-4722A/VRC (8 FT) (80058)	FT	
5995-00-823-2830	CX-4723/VRC (2 FT) (80058)	FT	
5995-00-823-2831	CX-4723/VRC (3 FT) (80058)	FT	
5995-00-823-2832	CX-4723/VRC (4 FT) (80058)	FT	

SECTION II ADDITIONAL AUTHORIZATION LIST

(1) NATIONAL STOCK NUMBER	(2) DESCRIPTION PART NUMBER AND FSCM USABLE ON CODE	(3) UNIT OF MEAS	(4) QTY AUTH
5995-00-823-2834	CX-4723/VRC (6 FT) (80058)	FT	
5995-00-823-2835	CX-4723/VRC (8 FT) (80058)	FT	
5995-00-823-2836	CX-4723/VRC (9 FT) (80058)	FT	
5995-00-823-2837	CX-4723/VRC (10 FT) (80058)	FT	
5995-00-823-2838	CX-4723/VRC (12 FT) (80058)	FT	
5995-00-823-2839	CX-4723/VRC (13 FT) (80058)	FT	
5995-00-823-2840	CX-4723/VRC (14 FT) (80058)	FT	
5995-00-823-2841	CX-4723/VRC (15 FT) (80058)	FT	
5995-00-823-2842	CX-4723/VRC (16 FT) (80058)	FT	
5995-00-823-2843	CX-4723/VRC (18 FT) (80058)	FT	
5995-00-889-0757	CX-4723/VRC (20 FT) (80058)	FT	
5995-00-823-2787	CX-7055/VRC (1.5 FT) (80058)	FT	
5995-00-889-0888	CX-7055/VRC (3 FT) (80058)	FT	
5995-00-823-2867	CX-7055/VRC (4 FT) (80058)	FT	
5995-00-889-1022	CX-7055/VRC (5 FT) (80058)	FT	
5995-00-823-2916	CX-7055/VRC (6 FT) (80058)	FT	
5995-00-823-2868	CX-7056/VRC (1 FT) (80058)	FT	
5995-00-823-2788	CX-7056/VRC (2 FT) (80058)	FT	
5995-00-823-2789	CX-7057/VRC (2 FT) (80058)	FT	
5995-00-889-1149	CX-7057/VRC (3 FT) (80058)	FT	
5995-00-933-4601	CX-7057/VRC (5 FT) (80058)	FT	
5995-00-823-2869	CX-7058/VRC (2 FT) (80058)	FT	
5995-00-823-2796	CX-7058/VRC (3 FT) (80058)	FT	
5995-00-889-0898	CX-7058/VRC (4 FT) (80058)	FT	
5995-00-889-0828	CX-7058/VRC (7 FT) (80058)	FT	
5995-00-823-2915	CX-7058/VRC (9 FT) (80058)	FT	
5995-00-823-2865	CX-7059/VRC (5 FT) (80058)	FT	
5995-00-261-9873	CX-7059/VRC (6 FT) (80058)	FT	
5995-00-985-8072	CX-7059/VRC (7 FT) (80058)	FT	
5995-00-823-2751	CX-7059/VRC (8 FT) (80058)	FT	
5995-00-889-0703	CX-7059/VRC (9 FT) (80058)	FT	
5995-00-823-2752	CX-7059/VRC (10 FT) (80058)	FT	
5995-00-823-2753	CX-7059/VRC (11 FT) (80058)	FT	
5995-00-889-0596	CX-7059/VRC (12 FT) (80058)	FT	
5995-00-889-0941	CX-7059/VRC (13 FT) (80058)	FT	
5995-00-935-0270	CX-7059/VRC (14 FT) (80058)	FT	
5995-00-889-0616	CX-7059/VRC (15 FT) (80058)	FT	
5995-00-889-0766	CX-7059/VRC (17 FT) (80058)	FT	
5995-00-261-9875	CX-7059/VRC (18 FT) (80058)	FT	
5995-00-985-8321	CX-7060/VRC (2 FT) (80058)	FT	
5995-00-926-0769	CX-7060/VRC (3 FT) (80058)	FT	
5995-00-926-0770	CX-7060/VRC (4 FT) (80058)	FT	

SECTION II ADDITIONAL AUTHORIZATION LIST

(1) NATIONAL STOCK NUMBER	(2) DESCRIPTION PART NUMBER AND FSCM	(3) UNIT OF MEAS	(4) QTY AUTH
5995-00-824-2782	CX-7060/VRC (5 FT) (80058)	FT	
5995-00-824-2785	CX-7060/VRC (6 FT) (80058)	FT	
5995-00-824-2784	CX-7060/VRC (7 FT) (80058)	FT	
5995-00-985-8351	CX-7060/VRC (9 FT) (80058)	FT	
5995-00-258-8407	CX-7060/VRC (10 FT) (80058)	FT	
5995-00-926-0778	CX-7060/VRC (11 FT) (80058)	FT	
5995-00-823-2802	CX-7408/VRC (2 FT) (80058)	FT	
5995-00-823-2803	CX-7408/VRC (4 FT) (80058)	FT	
5995-00-823-2797	CX-7555/VRC (3 FT) (80058)	FT	
5995-00-823-2799	CX-7555/VRC (6 FT) (80058)	FT	
5995-00-823-2870	CX-7601/VRC (2 FT) (80058)	FT	
5995-00-987-1331	CX-7671/VRC (6 FT) (80058)	FT	
5995-00-926-0815	CX-7867/VRC (6 FT) (80058)	FT	
5995-00-889-1130	CX-7867/VRC (10 FT) (80058)	FT	
5995-00-889-0784	CX-7867/VRC (12 FT) (80058)	FT	
5995-00-935-0383	CX-7867/VRC (13 FT) (80058)	FT	

APPENDIX E

EXPENDABLE SUPPLIES AND MATERIALS LIST

Section I. INTRODUCTION

E-1. Scope

This appendix lists expendable supplies and materials you will need to operate and maintain the AN/VRC-53, AN/VRC-64, AN/GRC-125, AN/GRC-160, OA-3633/GRC and OA-3633A/GRC. These items are authorized to you by CTA 50-970, Expendable Items (Except Medical, Class V, Repair Parts, and Heraldic Items). Battery, Dry BA-4366/U is authorized to you by SB 11-6. Battery, Dry BA-396/U is authorized to you for arctic use by SB 11-576.

E-2. Explanation of columns

a. Column 1—Item Number. This number is assigned to the entry in the listing and is referenced in the narrative instructions to identify the material (e.g., "Use trichloroethane, item 3, app E).

b. Column 2—Level. This column identified the lowest level of maintenance that requires the listed item.

C—Operator/Crew

O—Organizational Maintenance

F—Direct Support Maintenance

H—General Support Maintenance

c. Column 3—National Stock Number. This is the National stock number assigned to the item; use it to request or requisition the item.

d. Column 4—Description. Indicates the Federal item name and, if required, a description to identify the item. The last line for each item indicate the part number followed by the Federal Supply Code for Manufacturer (FSCM) in parentheses, if applicable.

e. Column 5—Unit of Measure (U/M). Indicates the measure used in performing the actual maintenance function. This measure is expressed by a two-character alphabetical abbreviation (e.g., ea, in, pr). If the unit of measure differs from the unit of issue, requisition the lowest unit of issue that will satisfy your requirements.

(Next printed page is E-3.)

SECTION II EXPENDABLE SUPPLIES AND MATERIALS LIST

TM 11-5820-498-12

(1) ITEM NO.	2 LEVEL	(3) NATIONAL STOCK NUMBER	(4) DESCRIPTION PART NO. AND FSCM	(5) UNIT OF MEAS
1	0	6135-00-926-8322	BATTERY, DRY BA-4386/U (80058)	EA
2	0	6135-01-034-2239	BATTERY, DRY BA-5598/U (80058)	EA
3	0	8040-00-753-4800	EPOXY	OZ
4	0	4240-00-542-2048	FACE SHIELD, INDUSTRIAL L-F-36 (81348)	EA
5	0	6850-00-880-7616	SILICONE COMPOUND DOW CORNING DC-4 (81349)	OZ
6	C	6850-00-105-3084	TRICHLOROTRIFLUOROETHANE, CLEANING COMPOUND, FREON PCA, TYPE T	PINT

Change 10 E-3/(E-4 Blank)

By Order of the Secretary of the Army:

HAROLD K JOHNSON,
General, United States Army,
Chief of Staff.

Official:

KENNETH G. WICKHAM,
Major General, United States Army,
The Adjutant General.

Distribution:

Active Army:

USASA (2)	TOAD (14)
CNGB (1)	ATAD (10)
OCC-E (7)	Sig FLDMS (2)
Dir of Trans (1)	AMS (1)
CofSpts (1)	USAERDAA (2)
TSG (1)	USAERDAW (13)
CofSpt (1)	USACRREL (2)
BOARDS (2)	Edgewood Arsenal (10)
USACDC Agencies (1)	Units org under fol TOE:
USAMC (5)	(2 copies each)
USCONARC (5)	1-55
ARADCOM (6)	1-59
ARADCOM Rgn (2)	1-207
OS Maj Cored (4)	5-35
LOGCOMD (2)	5-47
USAMICOM (4)	5-137
USASTRATCOM (4)	6-37
USAESC (70)	6-186
MDW (1)	6-186
Armies (2)	6-300
Corps (2)	6-346
USAC (3)	6-347
Svc Colleges (2)	6-385
Br Svc Sch (2) except	6-386
USASCS (5)	6-405
UASESCS (5)	6-415
Tng Centers (2)	6-416
WRAMC (1)	6-419
Army Pic Cen (2)	6-425
USACDCEC (10)	6-426
Instls (2) except	6-485
Ft Hancock (4)	6-436
Ft Gordon (10)	6-445
Ft Haachuca (10)	6-449
WSMR (6)	6-525
Ft Carson (25)	6-526
Ft Knox (12)	6-555
Gen Dep (2)	6-556
Sig Sec Gen Dep (5)	6-557
Sig Dep (12)	6-558
A Dep (2) except	6-565
LBAD (14)	6-575
SAAD (30)	

TM 11-5820--498-12

6-576	17-18
6-577	17-27
6-615	17-42
6-617	17-51
6-700	17-52
7-35	17-55
7-45	17-56
7-58	17-57
7-100	17-77
7-167	17-95
9-47	17-100
9-76	17-127
11-57	17-157
11-97	19-500 (QD-QH)
11-98	29-1
11-117	29-11
11-127	29-25
11-155	29-36
11-157	29-65
11-158	29-105
11-500 (AA-AC)	29-109
11-587	37
11-592	37-100
11-597	55-117
17	55-202
17-15	57
17-16	57-100

NG: None.

USAR: None.

For explanation of abbreviations used, see AR 320-50.

PIN : 030694-000